

**SYNTHESIS AND REACTIVITY OF
(SILYLANILINO)PHOSPHINES**

By

PRADEEP KUMAR DEVULAPALLI

Bachelor of Science, 1998
Osmania University
Hyderabad, India

Master of Science, 2000
Osmania University
Hyderabad, India

Submitted to the Graduate Faculty of the
College of Science and Engineering
Texas Christian University
In partial fulfillment of the requirements
For the degree of

Doctor of Philosophy

December 2007

Copyright by
PRADEEP KUMAR DEVULAPALLI
2007

ACKNOWLEDGEMENTS

I thank my advisor Professor Robert H. Neilson for his expert guidance and encouragement throughout the projects. I extend my words of appreciation for his invaluable time and commitment throughout my doctoral program. He always persuaded me to develop independent thinking and good research skills.

Special thanks go to my grandparents Smt. Gurram Shyamulamma and Sri Gurram Laxminarasaiah, for their care and concern, which always helped me to reach new heights of success.

I express gratitude to my mother Smt. Gurram Krishnamma and I feel that I am very much blessed for having such a confident, responsible, and loving mother. I am also indebted to my maternal uncle Dr. Gurram Nagaiah, without whom I would not have reached this stage. It is a pleasure to acknowledge my loving wife Madhavi for her invariable support and love.

I would also like to thank my family members, friends, and colleagues at the department of chemistry, Texas Christian University for their affection and support. Many thanks to the funding agency Robert A. Welch Foundation for their financial support.

To my mother

TABLE OF CONTENTS

Acknowledgements.....	ii
Table of Contents.....	iv
List of Tables.....	v
Literature Review.....	1
Section One.....	41
Synthesis and Reactivity of (Silylanilino)phosphines	
Section Two.....	100
Synthesis and Reactivity of (Silylamino)(silylanilino)phosphines and Synthesis of (Disilylanilino)phosphines	
Concluding Remarks.....	132
References.....	134
Vita	
Abstract	

LIST OF TABLES

Table

1. NMR Spectroscopic Data for Compounds C and D	59
2. NMR Spectroscopic Data for Compounds 1 - 12	61
3. NMR Spectroscopic Data for Compounds 13 - 17	73
4. NMR Spectroscopic Data for Compounds 18 - 21	78
5. NMR Spectroscopic Data for Compounds 22 - 29	82
6. NMR Spectroscopic Data for Compounds 30 - 31	90
7. Physical and Analytical Data for Compounds 1 – 17 and 22 - 28	92
8. NMR Spectroscopic Data for Compounds 32 - 37	112
9. NMR Spectroscopic Data for Compounds 38 - 41	118
10. NMR Spectroscopic Data for Compounds 42 - 43	122
11. NMR Spectroscopic Data for Compounds 46 - 48	124
12. Physical and Analytical Data for Compounds 32 – 41 and 46 - 48	127

LITERATURE REVIEW

INTRODUCTION

During the past five decades, the field of polymer chemistry has seen splendid growth, and has progressed into the 21st century, with an increasing emphasis on organic-inorganic composite materials. The research to be described in this dissertation is ultimately related to two types of polymer systems, polyphosphazenes and poly(phenylenevinylenes), that may eventually be combined into new inorganic-organic hybrid materials. Many recent studies have focused on poly(phenylenevinylene) and its derivatives mainly because of the electronic properties of these materials.¹ Depending on the substituents, polyphosphazenes² have a broad array of useful physical and chemical properties, such as flame retardancy, low or high glass transition temperatures, chemical resistance, high thermal stability, semi conductivity, bio-activity and bio-degradability or bio-inertness.²⁻⁵

Traditionally, polyphosphazenes are synthesized by two well developed methods. The first and most widely studied method is the ring-opening polymerization of cyclic phosphazenes, developed by Allcock et al (eq 1).⁶

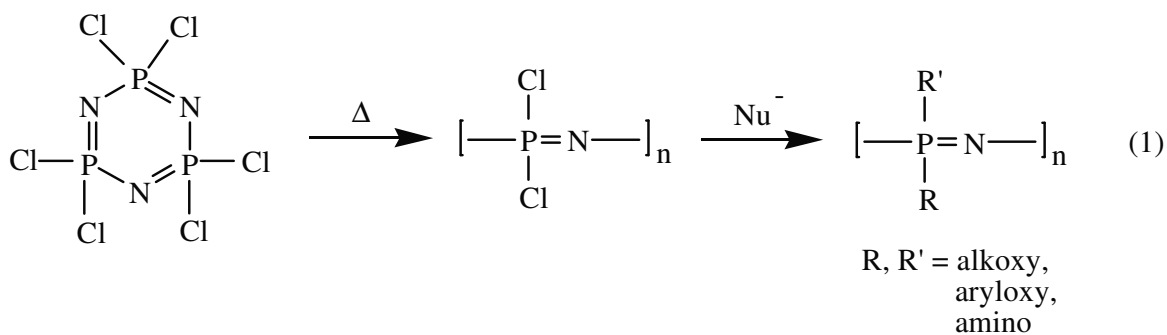

The second general method, discovered and developed by Neilson and Wisian-Neilson,⁵⁻¹⁰ is based on the condensation polymerization of suitably substituted *N*-silylphosphoranimines (eq 2).



X = alkoxy, aryloxy

R, R' = alkyl, aryl

By combining the core properties of two well established classes of polymers, polyphosphazenes and poly(phenylenevinylenes), new hybrid polymers with an organic (phenylene) spacer group between P=N units in the backbone could be good candidates for a large number of potential applications. Using the Staudinger reaction, Herring¹¹ synthesized the first linear system where an organic moiety (phenyl ring) regularly alternates with the P=N bond. Later, Pomerantz and co-workers¹² synthesized and characterized a series of oligomers containing organo- λ^5 -phosphazene backbone moieties. More recently, Lucht and co-workers¹³ investigated the electron donating properties of *p*-phenylene phosphine imides. To date, however, fully characterized poly(phenylene-phosphazenes), where a phenyl ring regularly alternates with P=N units, and are structurally analogous to poly(phenylenevinylene), have not been reported.

Two general types of Si-N-P compounds that are relevant to this work are the aminophosphines (**I**), in which phosphorous is three coordinate and trivalent, and the phosphoranimines (**II**), in which phosphorous is four coordinate and pentavalent. The phosphoranimines are often synthesized from aminophosphines via oxidation reactions.

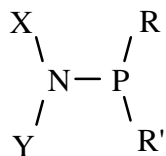

I

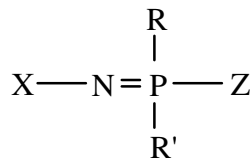

II

This literature review will provide a broad overview of some preparative chemistry which is pertinent to the research presented in this dissertation and will cover the following specific sections.

- (1) Synthesis and reactivity of (silylamino)phosphines
- (2) Reactivity of *N*-silylphosphoranimines
- (3) Synthetic routes to polyphosphazenes
- (4) Reactivity of polyphosphazenes
- (5) Synthesis of polyphosphazenes containing spacer groups

SYNTHESIS AND REACTIVITY OF (SILYLAMINO)PHOSPHINES

Synthesis

Symmetrically substituted (silylamino)phosphines were reported during the 1960's and 1970's (eq 3).¹⁴ However, this method is tedious and limited, due to the difficulty in the synthesis and handling of large quantities of the desired dialkylchlorophosphines.

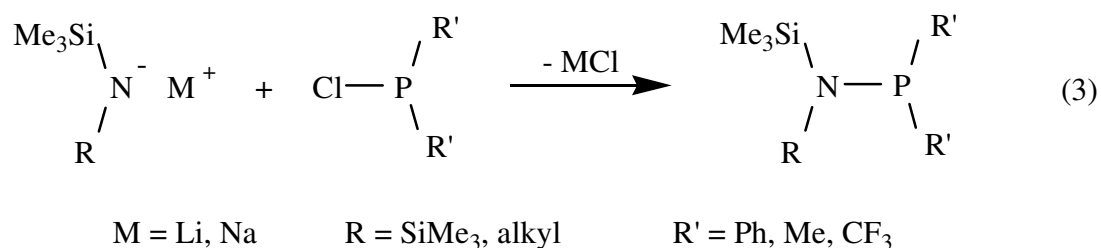

An extremely versatile and convenient “one-pot” synthesis of symmetrical (silylamino)dialkylphosphines is the Wilburn method,¹⁵ discovered and developed by Neilson and Wilburn, (named in the honor of Neilson’s late co-worker, J. C. Wilburn) (eq 4). This method is also useful for the synthesis of unsymmetrical (silylamino)alkyl/arylphosphine derivatives, provided that the first substituent is sufficiently bulky (eq 5).¹⁵⁻¹⁷

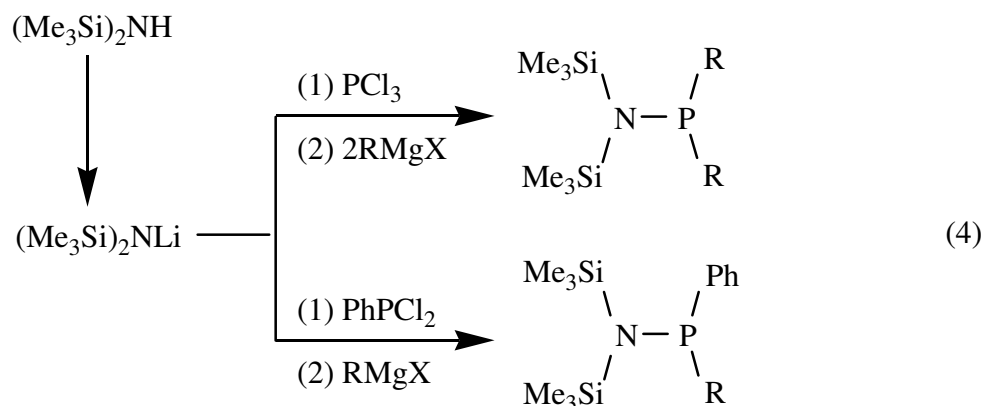

R = Me, Et, *n*-Pr, *i*-Pr, *n*-Bu, CH₂Ph, CH=CH₂, CH₂CH=CH₂, CH₂SiMe₃

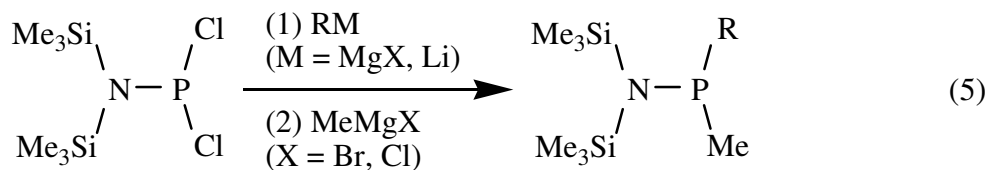

R = CH₂SiMe₃, *n*-Pr, *i*-Pr, *t*-Bu, CH=CH₂, C₆H₄OCF=CF₂

In summary, the Wilburn method is and will be the general route for the synthesis of virtually any (silylamino)phosphine in good yield.

Reactivity

Oxidation reactions of (silylamino)phosphines by various oxidizing reagents often produce *N*-silylphosphoranimines, the precursors for the polyphosphazenes, which will be reviewed in the following sections.

Staudinger Reaction. In 1919, Staudinger and Meyer¹⁸ discovered and reported the first synthesis of phosphoranimines by reacting phosphines with azides. The Staudinger reaction is a two step reaction which involves the initial addition of an organic azide to the phosphorous center, to form a phosphoazide intermediate, followed by the elimination of N₂ to yield the phosphoranimine (eq 6).

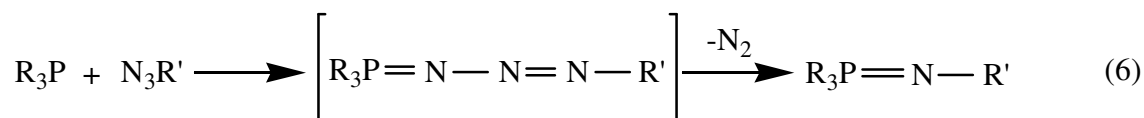

R, R' = alkyl, aryl

The organic azides are often explosive in nature but this limitation does not pertain to organosilicon azides. In 1962, West and Thayer¹⁹ synthesized the first *N*-silylphosphoranimines using triphenylphosphine and trialkyl/arylsilyl azides (eq 7). These newly synthesized organosilicon azides are highly thermally stable (possibly due to Si-N $d\pi-p\pi$ interactions) and are versatile reagents for the synthesis of *N*-silylphosphoranimines in good yields.

Neilson and co-workers have synthesized numerous *N*-silylphosphoranimines with trimethylsilylazide and (silylamino)phosphines²³ (eq 11 – 14). Depending on the substituents, R and R¹ on the nitrogen atoms, intramolecular [1,3]-silyl migration can occur resulting in structural rearrangements (eq 11, 13, 15).

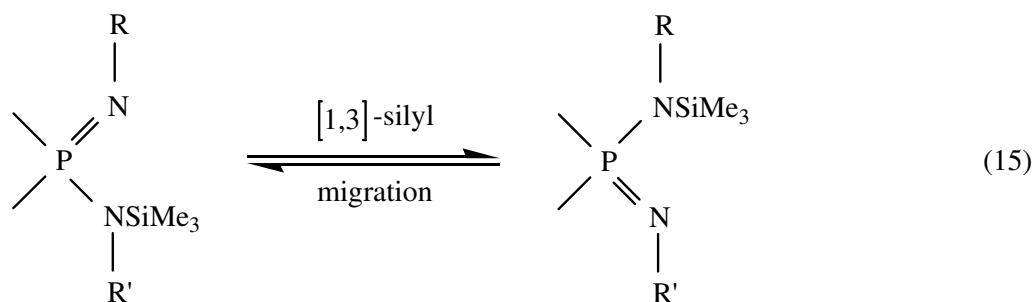
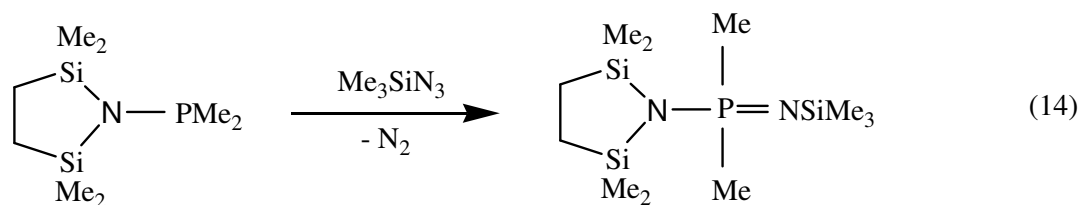
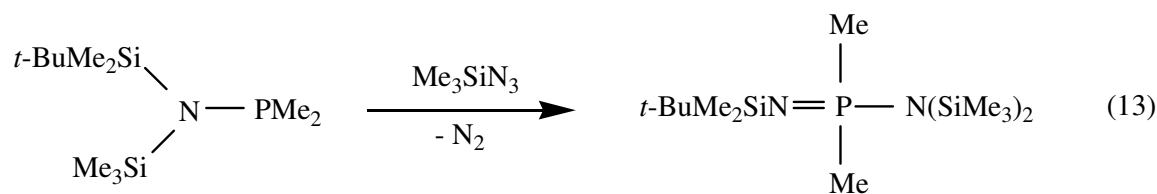
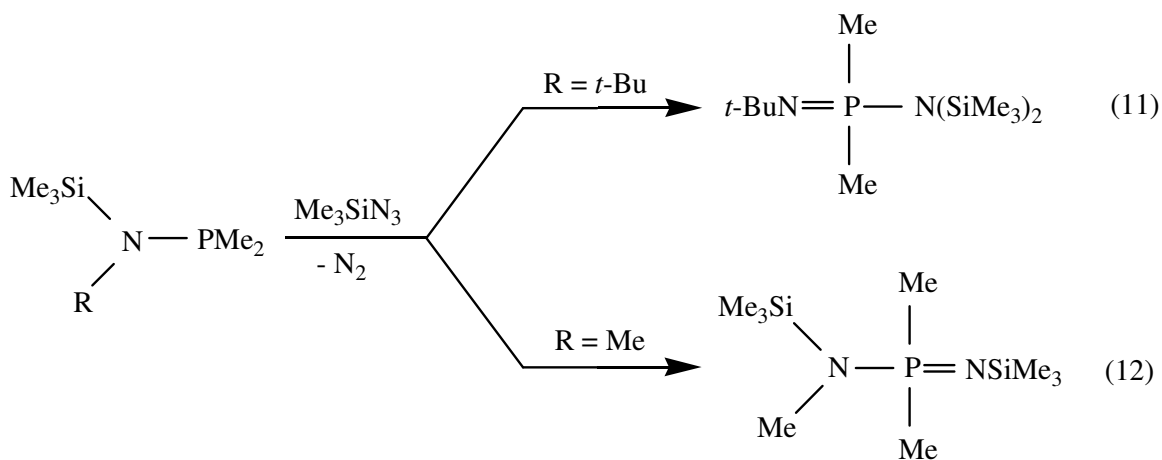

Similarly when phosphines containing at least one alkoxy group are used in the Staudinger reaction, the migration of the alkyl group occurs from oxygen to nitrogen (eq16).^{24, 25}

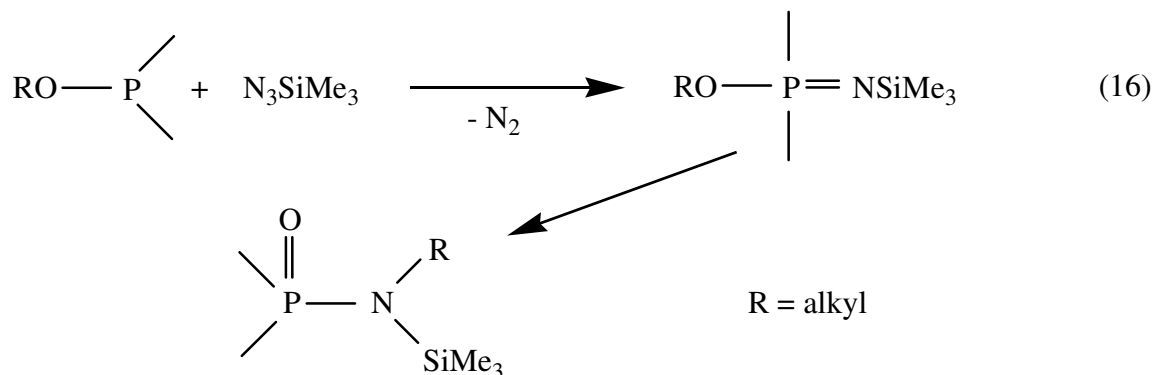

In the 1970's, Niecke and Flick²⁶ and later Neilson¹⁶ used the Staudinger reaction to synthesize three-coordinate phosphoranimines (eq 17) from novel two-coordinate (silylamino)phosphines. When halophosphines are used, cyclic phosphazenes are formed from the decomposition of azidophosphine intermediates (eq 18).

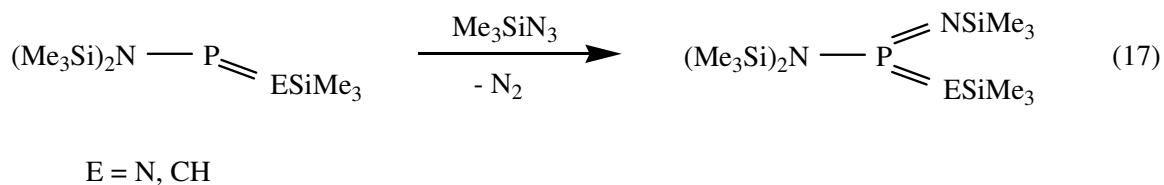

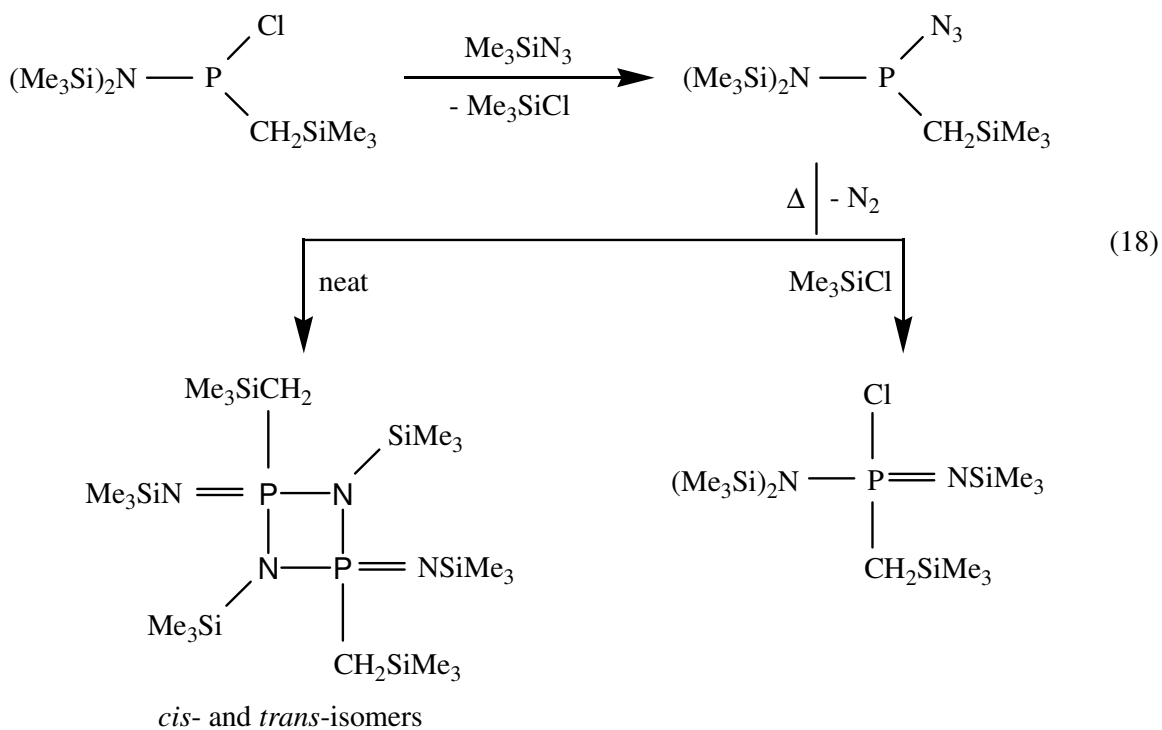

Oxidation Reactions. In addition to the Staudinger reaction, (silylamino)phosphines are readily converted into *N*-silylphosphoranimines by treatment with various oxidizing agents like O_2 , Br_2 , C_2Cl_6 , CCl_4 , carbonyl compounds, and also with organic halides.

Some (silylamino)phosphines react with dry oxygen to form *N*-silyl-*P*-siloxyphosphoranimines. The initial attack of oxygen on phosphorous (III) results in the formation of a phosphine oxide intermediate. Subsequently, migration of one silyl group from nitrogen to oxygen occurs (eq 19).^{14c, 27}

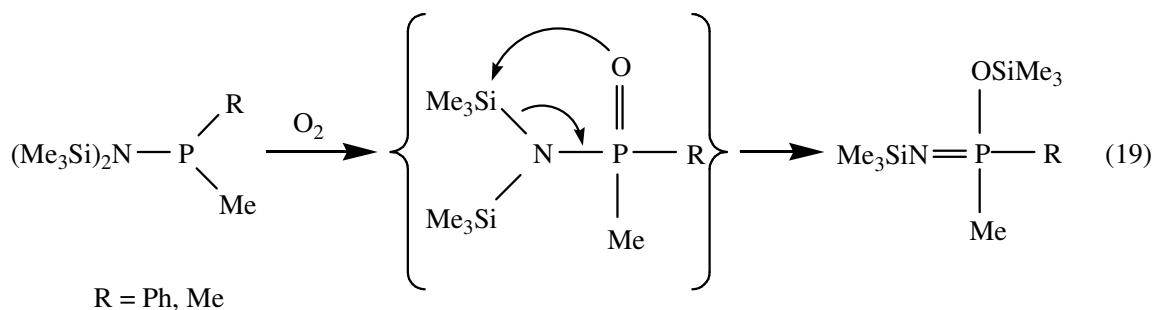

N-silylphosphoranimines are also obtained by reacting (silylamino)phosphines with organic carbonyl compounds. Morton and Neilson²⁸ reported that this reaction proceeds through nucleophilic attack by the phosphorous atom on the carbonyl carbon, followed by a [1,4]-silyl migration from nitrogen to oxygen (eq 20).

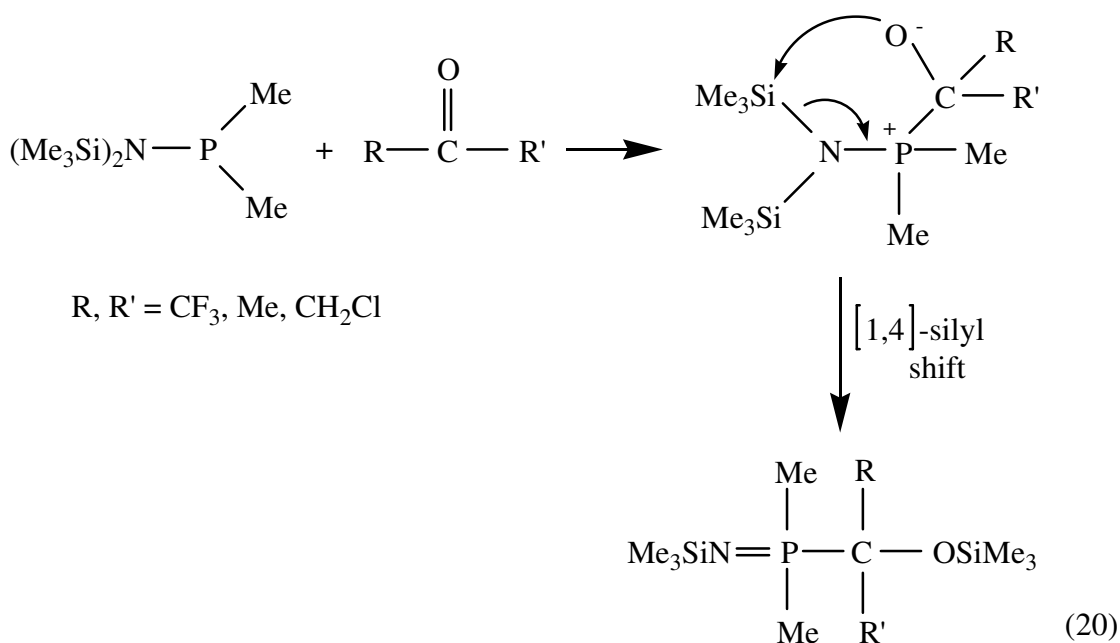

In another paper Morton and Neilson²⁹ reported that the (silylamino)phosphines react with organic halides to form phosphonium salts which then eliminate silyl halide to give *N*-silylamino phosphoranimines (eq 21).

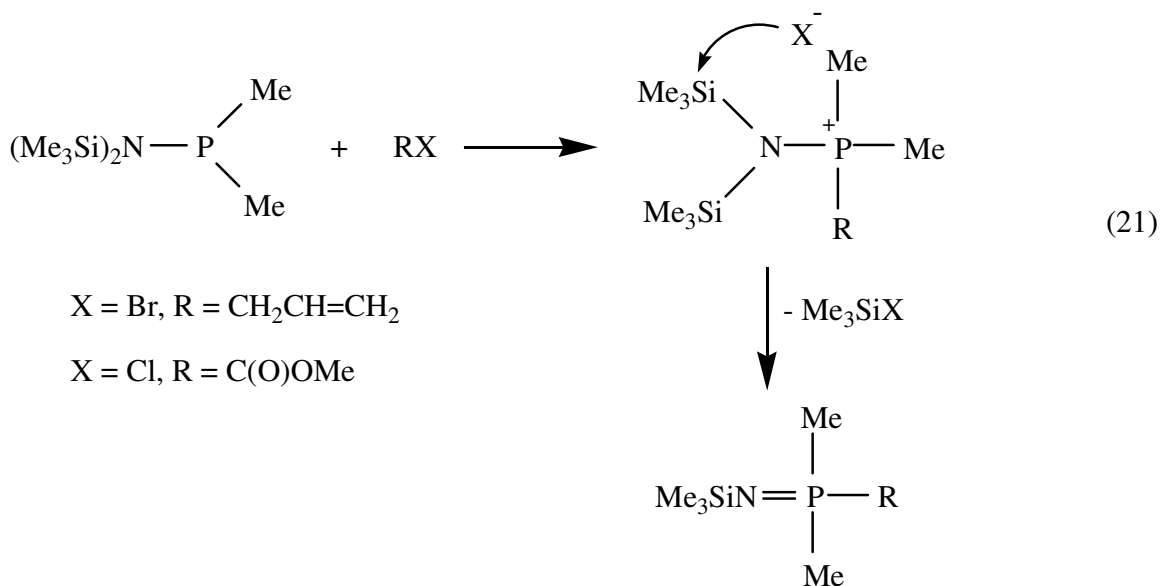

Treatment of (silylamino)phosphonium salts with *n*-butyl lithium affords an ylide intermediate which undergoes a [1, 3]-silyl shift from N to C, to yield *N*-silylphosphoranimines (eq 22).²⁹

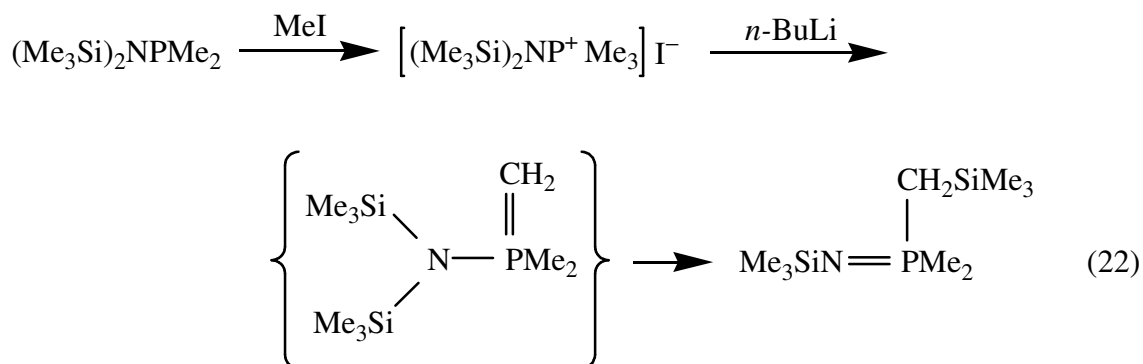

Tertiary phosphines containing at least one CH proton α to phosphorous react with CCl_4 to yield ylides and CHCl_3 .³⁰ On the other hand, with phosphines containing the disilylamino group, an additional reaction pathway, cleavage of a Si – N bond and elimination of $\text{Me}_3\text{SiCCl}_3$, is seen (eq 23).³¹

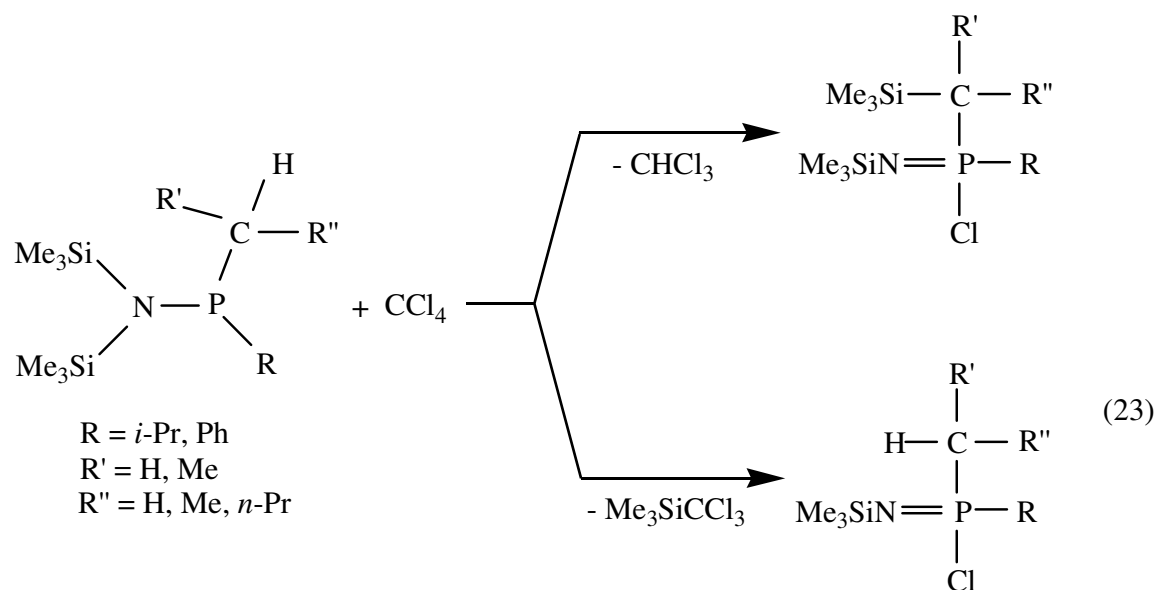

Also, halogenation reagents like Br_2 (eq 24)³² and hexachloroethane (eq 25)³³ react readily with (silylamino)phosphines, eliminating Me_3SiX ($\text{X} = \text{Br, Cl}$), to yield the desired N-silylphosphoranimine. The reaction proceeds through the initial nucleophilic attack by the phosphorous atom on the halogen to form a phosphonium ion intermediate, which undergoes halosilane elimination to form the P-halogenated product.

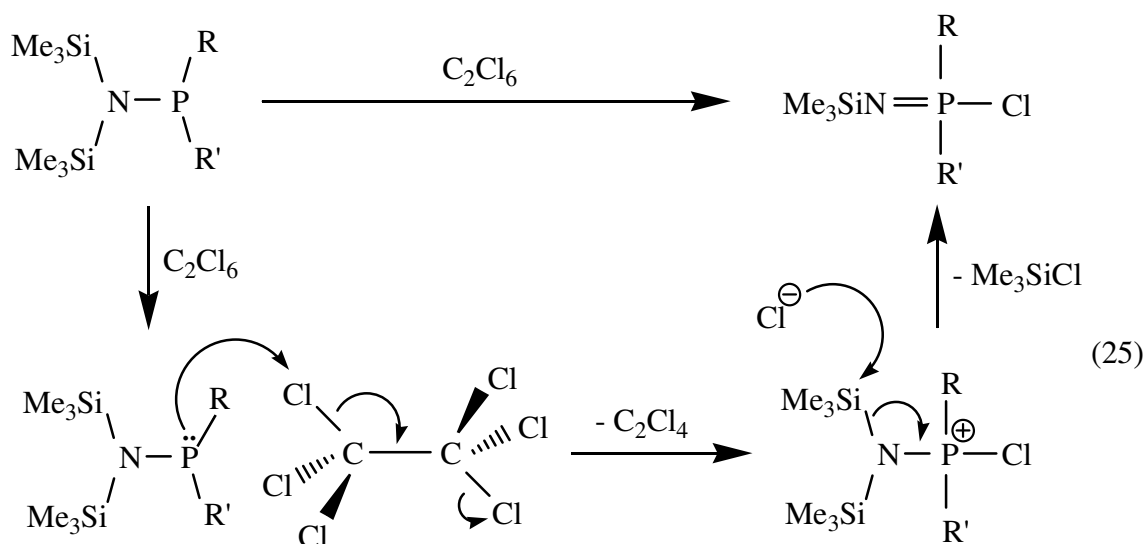
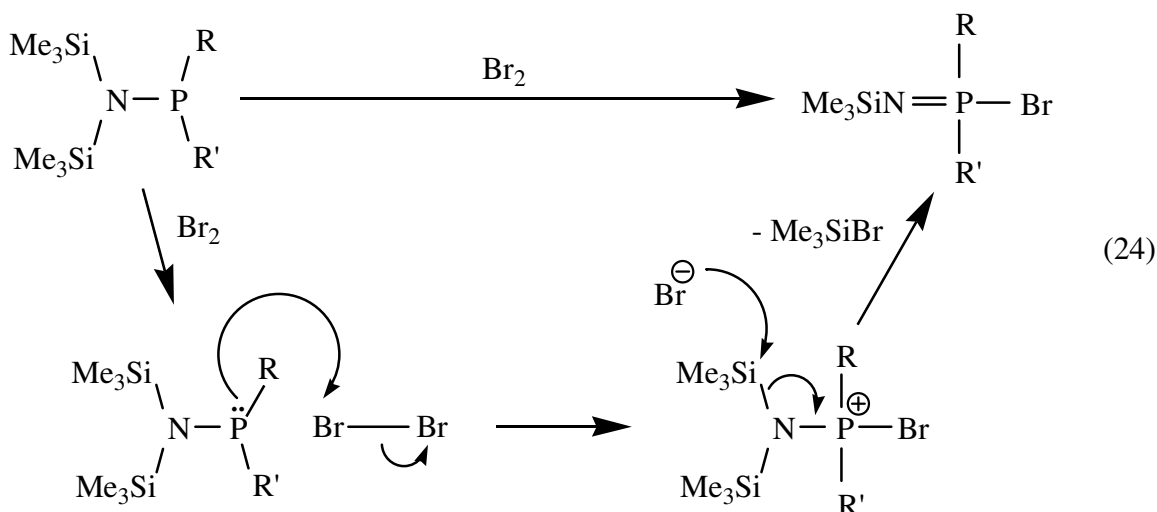

REACTIVITY OF *N*-SILYPHOSPHORANIMINES

The *N*-silylphosphoranimines have a rich derivative chemistry. The four general modes of reactivity (**Scheme 1**), which are relevant to the current research, are:

(a) nucleophilic substitution at the phosphorous center, (b) deprotonation-substitution at

the $P\text{-CH}_3$ group, (c) Si-N bond cleavage, and (d) condensation polymerization. The condensation polymerization method will be reviewed in the next section.

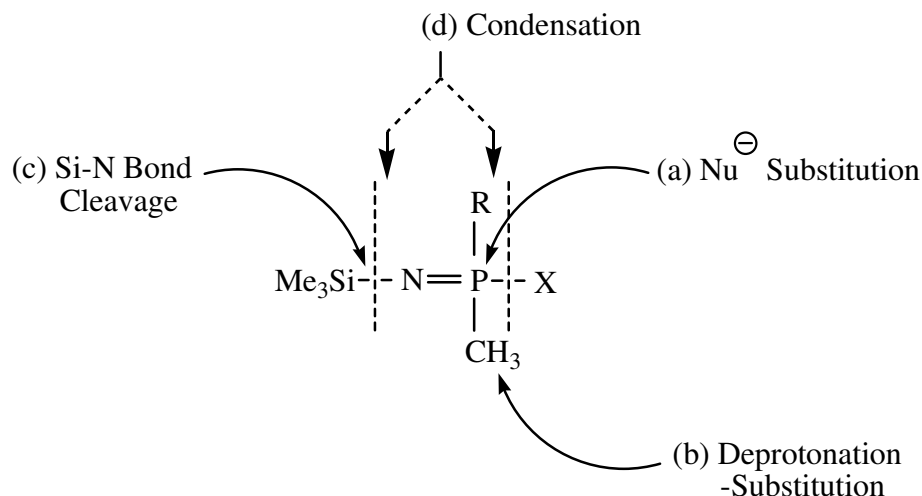

Scheme 1. Reactive sites of *N*-silylphosphoranimines

Nucleophilic Substitution at Phosphorous. The *N*-silyl-*P*-halophosphoranimines shown above are thermally unstable and, upon thermolysis, they often form cyclic phosphazenes. Thermal stability can be achieved by replacing the halogen substituent with amino, alkoxy, or aryloxy groups^{32, 33} (eq 26).

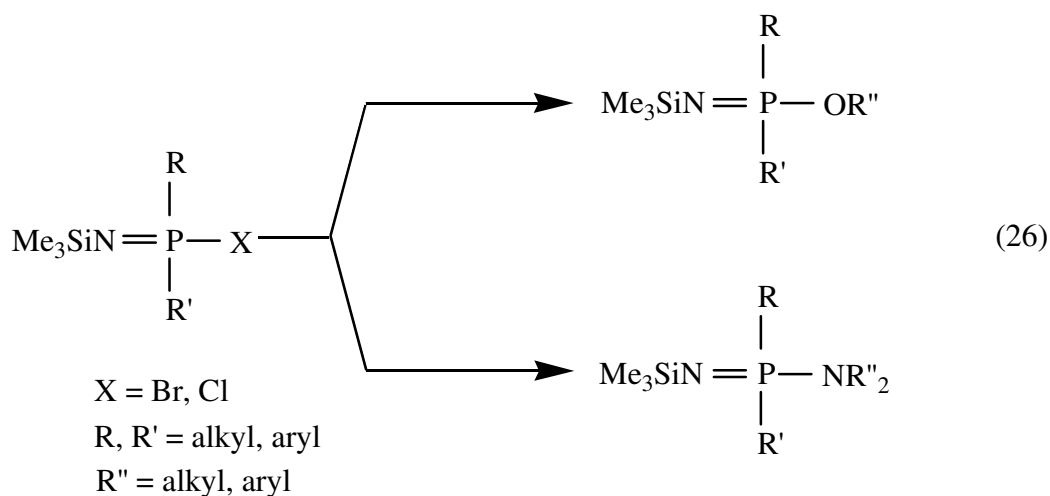

Deprotonation-Substitution at the *P*-CH₃ Group. In 1967, Schmidbaur³⁴ reported that the *P*-CH₃ groups of *N*-silylphosphoranimines could be deprotonated to form a carbanion that was then substituted by an electrophile (eq 27)

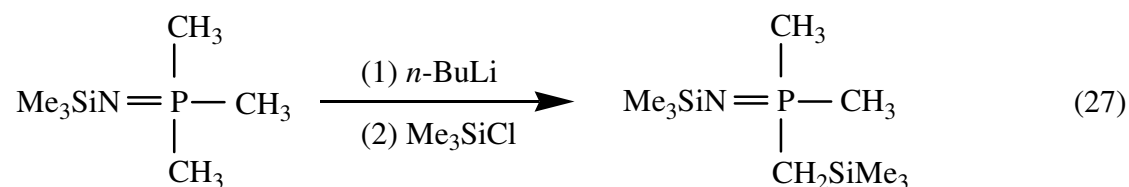

Later, Neilson and co-workers³⁵ exploited this reaction and synthesized a wide variety of C-substituted *N*-silylphosphoranimine derivatives (eq 28).

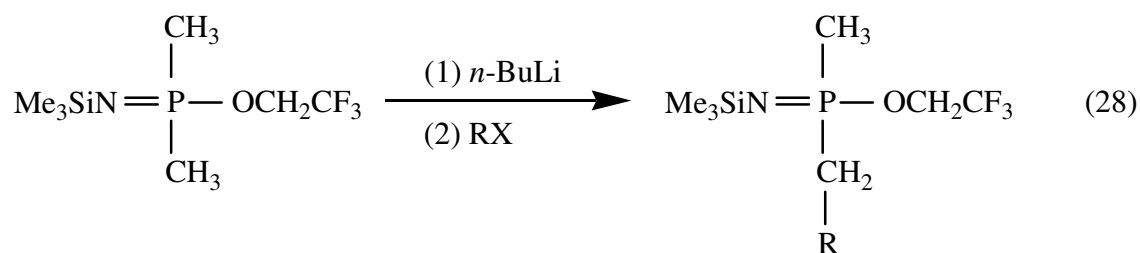

R = Me, CH₂Ph, CH₂CH=CH₂, PPh₂, P(NMe₂)₂, R'Me₂Si, Br

Upon treatment with Fe(CO)₅, the C-phosphinyl phosphoranimines gave the expected metal complexes.^{35a} The C-silylated phosphoranimines, upon thermolysis, did not give polymers, which shows their enhanced thermal stability.^{35c} However, when the C-silylated phosphoranimines are deprotonated, the resulting anions react with carbonyl compounds and chlorotrimethylsilane to yield the corresponding *N*-silylphosphoranimines with pendant vinyl groups (eq 29). This process is a variation of the Peterson olefination reaction.³⁶

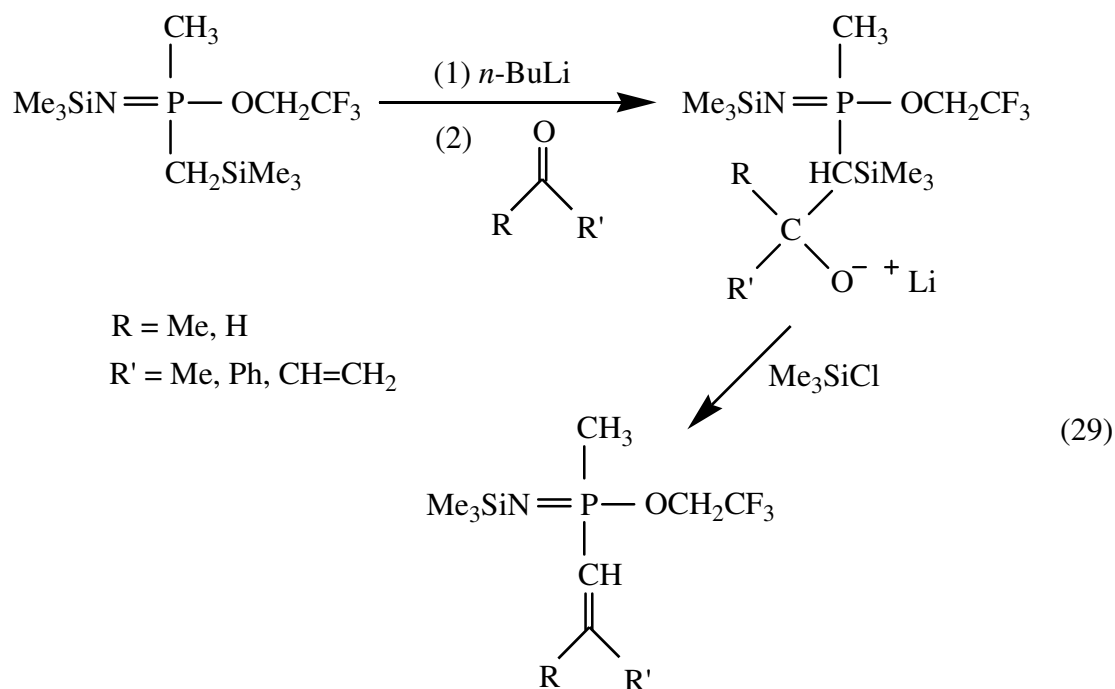

When the C-silyl group is not present, similar reactions produce the simple silyl ether derivatives in good yields (eq 30).³⁷

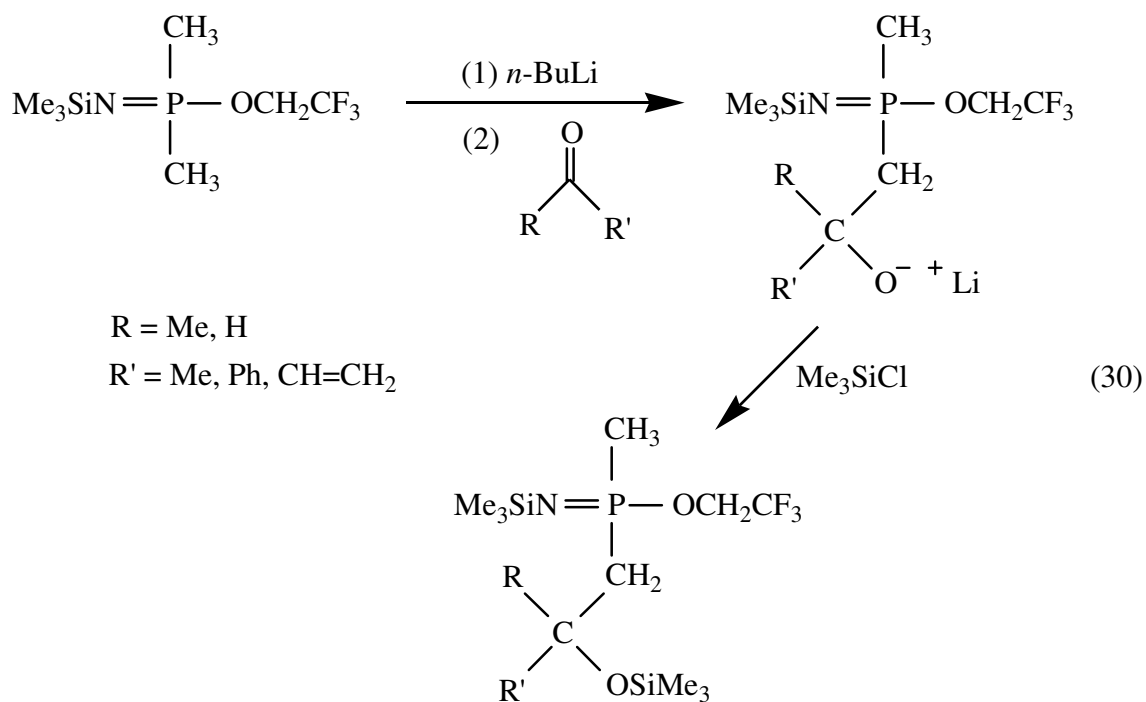

Si-N Bond Cleavage Reactions. Most *N*-silylphosphoranimines undergo facile Si-N bond cleavage reactions usually by eliminating Me_3SiCl as the byproduct. By transsilylation reactions, in which one silyl group is replaced by another, Wolfsberger³⁸ synthesized a wide variety of *N*-(halosilyl)phosphoranimines (eq 31), and *P*-trialkyl/triaryl-*N*-silylphosphoranimines (eq 32).

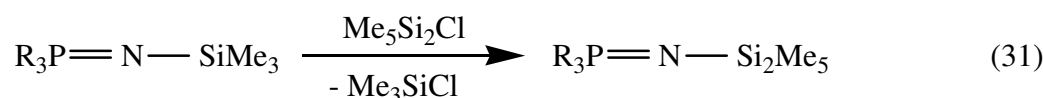

$\text{R} = \text{Me, Et, } n\text{-Bu, } i\text{-Bu, } t\text{-Bu, Ph}$

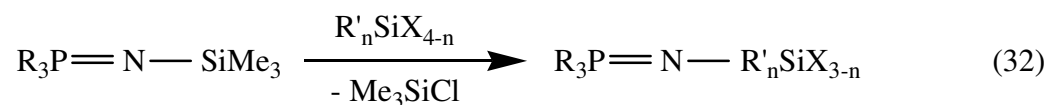

$\text{X} = \text{F, Cl, Br}$

Wettermark and Neilson³⁹ reported a series of transsilylation reactions with the *P*-alkoxyphosphoranimines (eq 33). Similarly, di/trichlorophosphines react with phosphoranimines to yield bis/tris(phosphoranimino)phosphines⁴⁰ (eq 34, 35).

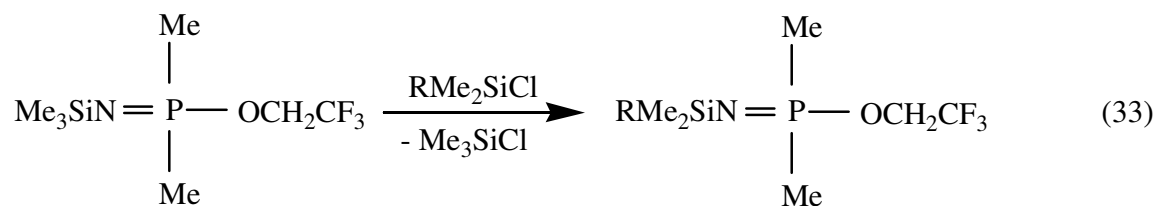

$\text{R} = \text{Ph, CH}=\text{CH}_2, \text{CH}_2\text{Cl, (CH}_2)_3\text{CN, CH}_2\text{CH}_2\text{OC(O)CH}_3$

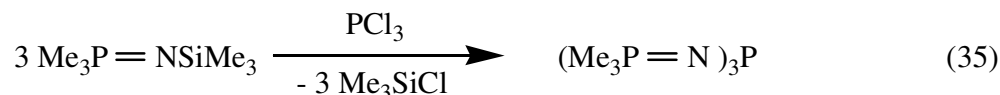
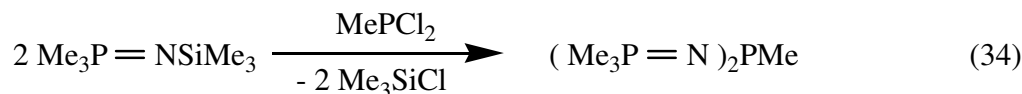

Birkofer and Kim⁴¹ synthesized N-H phosphoranimines (eq 36), by reacting phosphoranimines with methanol in the presence of traces of sulfuric acid. The N-H functional group can be deprotonated to afford derivatives.

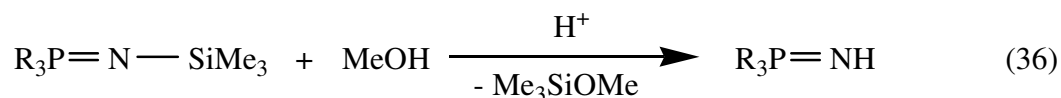

By exploiting the facile cleavage of the N-Si bond, Flindt⁴² has synthesized several (*N*-phosphinyl)phosphoranimines (eq 37) by reacting trifluoroethoxy/phenoxy phosphines with *N*-silylphosphoranimines. He also synthesized low molecular weight polyphosphazenes which will be discussed later.

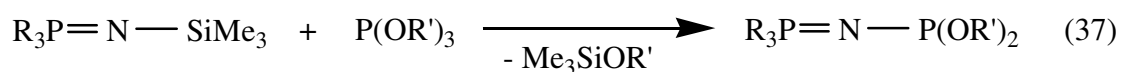

R = Me, NMe₂, Ph

R' = CH₂CF₃, Ph

SYNTHETIC ROUTES TO POLYPHOSPHAZENES

In 1897⁴³ Stokes reported the synthesis of insoluble and hydrolytically unstable poly(dichlorophosphazene) produced through ring-opening polymerization. Later, Allcock et al, in 1965⁶, reported the first synthesis of soluble, non cross-linked, well-characterized polyphosphazenes via ring-opening polymerization. More recently, Neilson and Wisian-Neilson^{3, 5} discovered the condensation route for the synthesis of polyphosphazenes. Condensation polymerization is an extremely versatile route for the synthesis of virtually any alkyl/aryl substituted polyphosphazene. In this section, these synthetic methods and their modifications for the synthesis of polyphosphazenes will be briefly reviewed.

Ring-Opening Polymerization. Poly(dichlorophosphazene), originally called “inorganic rubber”, is synthesized from the cyclic trimer of dichlorophosphazene, $(\text{Cl}_2\text{PN})_3$. When heated to about $250\text{ }^\circ\text{C}$, the trimer is thermally ring-opened to form soluble, linear, high molecular weight polymer, which can undergo further nucleophilic substitutions with alkoxy, aryloxy, or amino moieties to form a wide variety of useful polyphosphazenes (eq 38).^{4, 6} When the trimer is heated beyond $250\text{ }^\circ\text{C}$, approximately to $350\text{ }^\circ\text{C}$, it forms an insoluble, cross-linked product. By randomly substituting with different nucleophiles, various co-polymers can also be produced. The physical and chemical properties can be significantly diversified by changing the side groups.

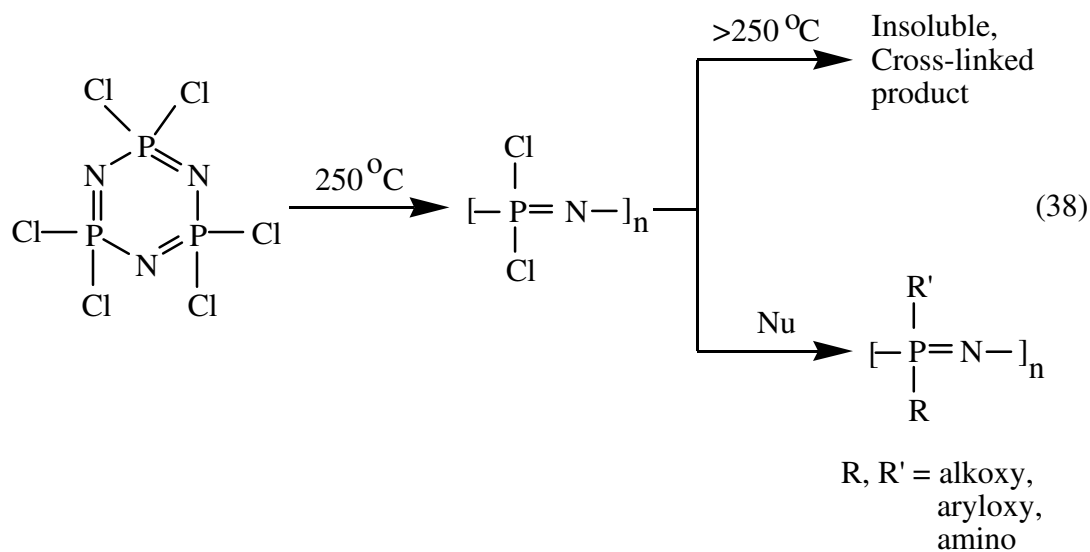

Although ring-opening polymerization of certain partially alkyl substituted cyclic phosphazenes affords some alkyl substituted polyphosphazenes (eq 39)⁴⁴, the fully alkyl substituted cyclic phosphazenes cannot be ring-opened to form the corresponding polymers.⁴⁵

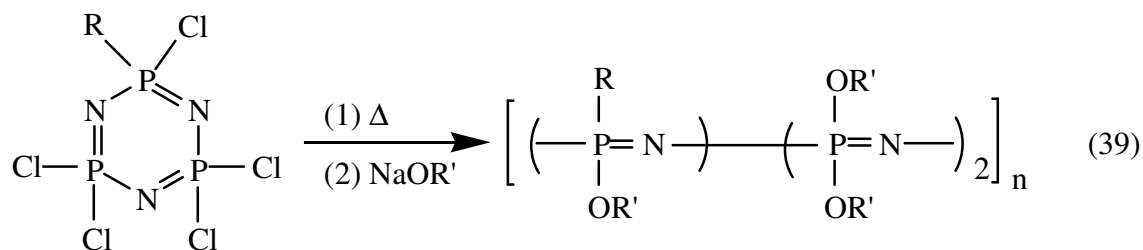

While a wide variety of alkoxy, aryloxy, or amino substituted phosphazenes are synthesized by this method, the thermally and chemically more stable P-C bonded alkyl, aryl substituted polyphosphazenes cannot be prepared from substitution reactions of poly(dichlorophosphazenes).

Condensation Polymerization. Condensation polymerization is one of the most commonly employed methods for the synthesis of organic polymers, often from a starting material containing two functional groups (eq 40).

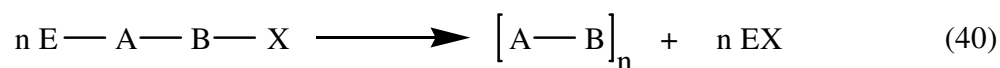

This type of polymerization process can be extended to obtain polyphosphazenes. This method is versatile in that virtually any *P*-substituted (including P-C substituted) polyphosphazenes can be synthesized. The monomers in the condensation polymerization should be thermally stable and should contain functional groups that lead to inert byproducts such as silyl ethers. Certain types of *N*-silylphosphoranimines are suitable candidates for the thermal condensation polymerization to afford the desired polyphosphazenes.

Flindt and Rose⁴⁶ published the first synthesis of poly[bis(trifluoroethoxy)phosphazene] ($M_w \approx 10,000$), obtained by the thermolysis of tris(trifluoroethoxy)phosphoranimine (eq 41). The byproduct in this reaction is the stable trifluoroethoxysilane.

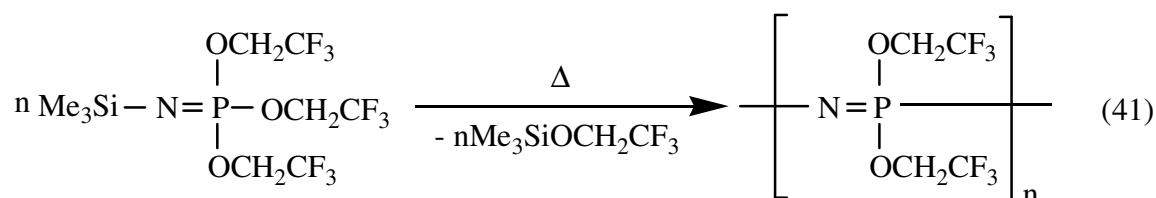

In 1980, Wisian-Neilson and Neilson⁷ synthesized the first, fully substituted poly(alkyl/arylphosphazene) via the thermal condensation of an *N*-silyl-*P*-trifluoroethoxyphosphoranimine. The polymerization process is smooth and quantitatively yields polymers with high molecular weights ($M_w \approx 50,000$) (eq 42).

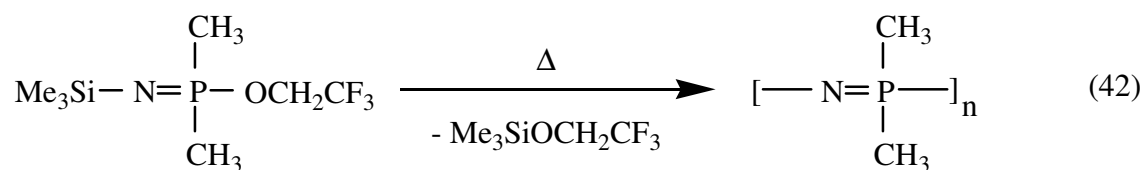

The authors synthesized several poly(alkyl/arylphosphazenes)^{5, 15c} and developed the thermal condensation process as a general method for the preparation of phosphazene polymers (eq 2). The authors also demonstrated that less expensive phenoxy substituted *N*-silylphosphoranimines can undergo thermal decomposition to afford polyphosphazenes in high yields (eq 43).³

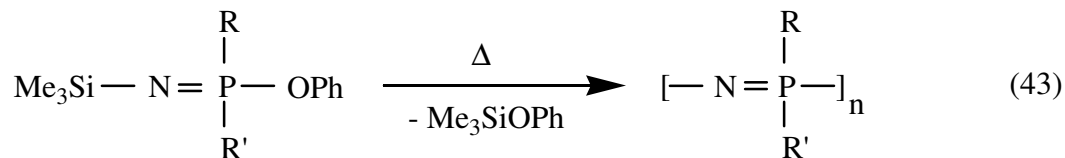

R, R' = alkyl, aryl

The *N*-silylphosphoranimine monomers are prepared from readily available PCl_3 or PhPCl_2 (eq 4, 5, 24, 25, 26). The resulting monomers are sealed in an evacuated glass or stainless steel ampules, and heated to 160-220 °C for 2-12 days. Polymers produced by the condensation method have high molecular weights ranging from 50,000 to 250,000 (M_w), with polydispersity index values between 1.5 and 2.5. Since reactions quenched even at low conversions show the presence of high molecular weight polymers, a chain growth mechanism rather than the more common step growth mechanism seems to be operating.

In addition to homopolymers, several desired copolymers are also synthesized by thermal condensation of mixtures of two different monomers.⁴⁷ The monomer ratio in the copolymers was varied from 1:5 to 5:1 (eq 44). Monomers containing more complex groups attached to the phosphorous center may also form polymers. For example, phosphino groups in the polymer form complexes with transition metals (eq 45). Similarly, the presence of alkenyl groups results in cross-linked polymers (eq 46).^{5, 32b} However, *N*-silylphosphoranimines containing a silyl group attached to the α -carbon do not undergo thermolysis to give polymers.⁵

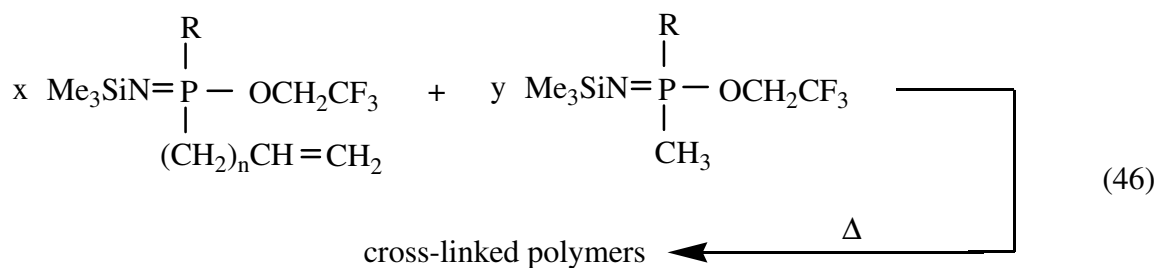
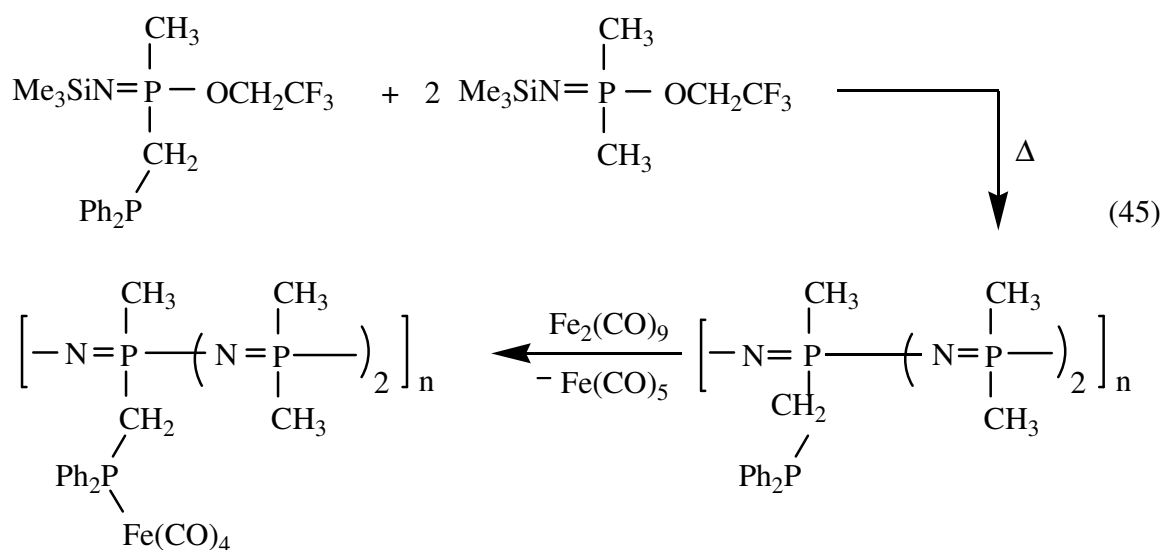
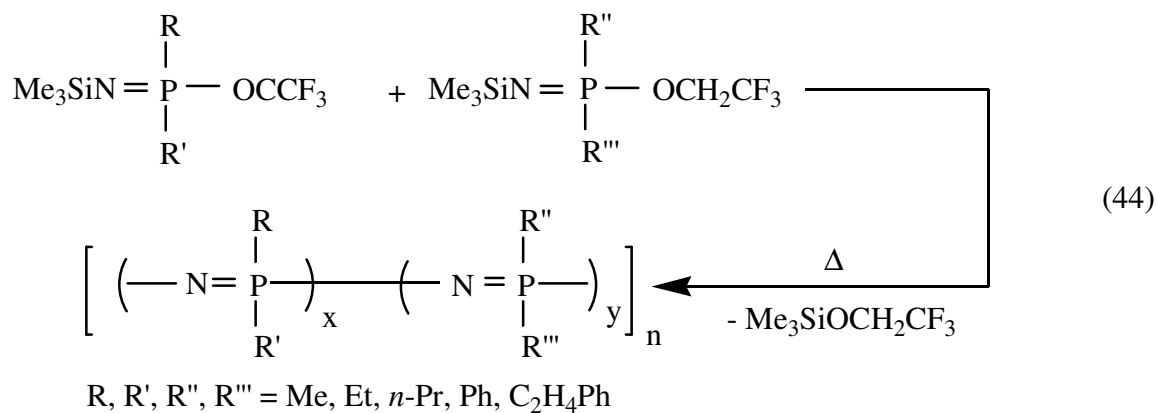

$n = 0, 1, 2$ $\text{R} = \text{Me, Ph}$ $x:y = 1:1, 1:2, 1:5, 1:10, \dots$

While the substitution pattern in such copolymers is often random, the employment of diphosphazenes in thermolysis can be used to prepare regularly alternating copolymers (eq 47).⁴⁸

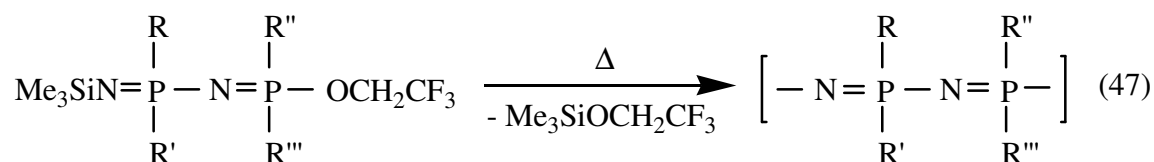

R, R', R'', R''' = alkyl, aryl

High molecular weight polyphosphazenes are obtained at lower temperatures and in relatively shorter times⁴⁹ when the condensation is carried out in the presence of tetrabutylammonium fluoride, a source of fluoride ion catalyst. The process involves bimolecular reactions of anionic intermediates. Other catalysts such as NaOPh⁵⁰, (Me₂N)₃P=O, and HMPA that speed up the condensation process have also been studied.³³ More recently, Cl₃P=NSiMe₃ has been used as a precursor to prepare poly(dichlorophosphazene) with narrow polydispersities. The reaction uses Lewis acids as catalyst at ambient temperatures, both in solution and bulk state polymerizations. The resulting poly(dichlorophosphazene), on nucleophilic substitution, gave hydrolytically stable polymer (eq 48).⁵¹

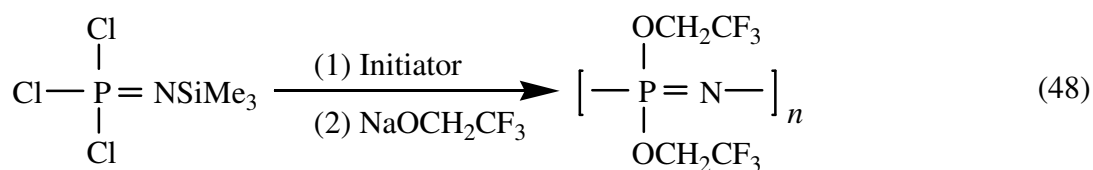

Initiator = PCl₅, PBr₅, Ph₃C(PF₆), Ph₃C(SbCl₆), SbCl₅, VCl₄

It is believed that the reaction is a “living” polymerization process, and by altering the monomer to initiator ratio, the molecular weights of the polymer can be controlled. The polymerization process is a chain-growth process, which involves a cationic intermediate (**Scheme 2**).⁵¹

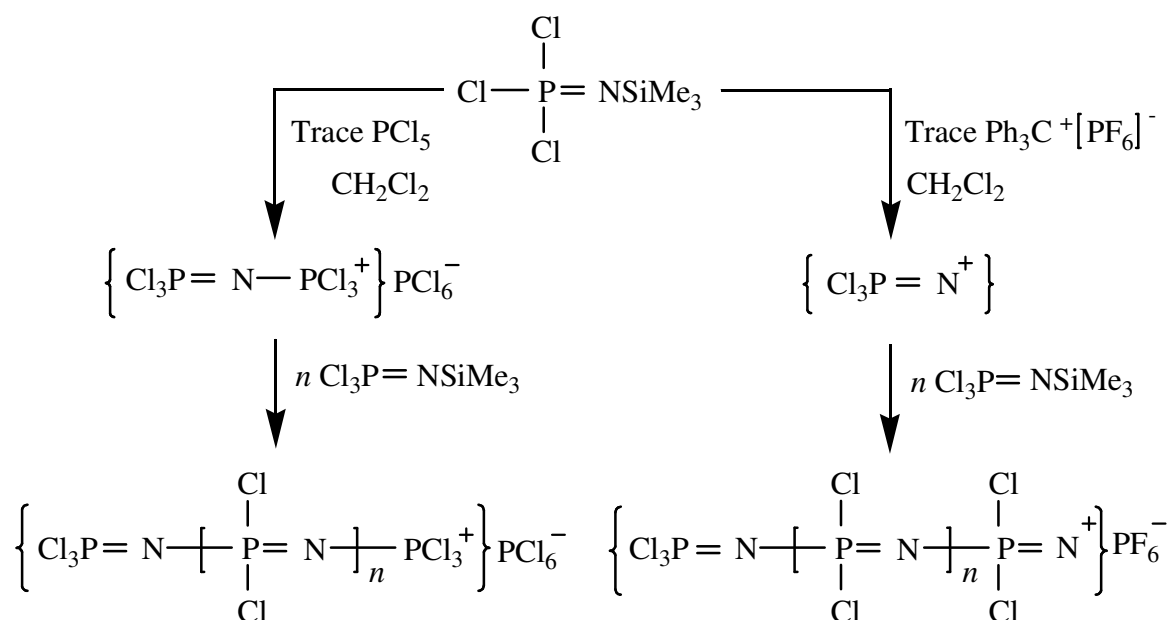

Scheme 2

The above mentioned ambient-temperature “living” cationic polymerization has also been applied to *P*-halo(alkyl/aryl)phosphoranimines⁵² to yield the corresponding poly(alkyl/arylphosphazenes). When different monomers are used in step-wise fashion, in the controlled cationic, ambient temperature polymerization, block copolymers are formed (eq 49).^{53a}

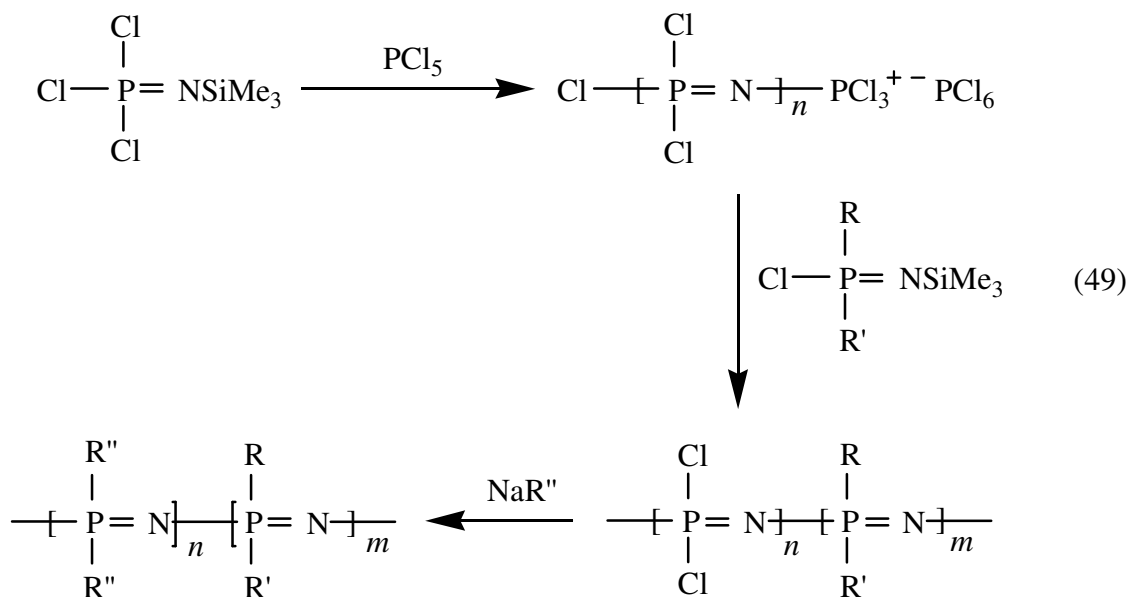

Using this process, various tri-armed, star-shaped polyphosphazenes,^{53b} telechelic polyphosphazenes,^{53c} and telechelic phosphazene siloxane block copolymers^{53d} have been synthesized.

The uncatalyzed thermal condensation of halophosphoranimines also yielded some novel polyphosphazenes with fluorocarbon side groups (eq 50).⁵⁴

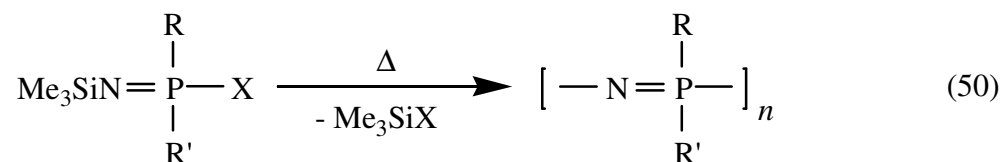

Poly(dichlorophosphazene) is also obtained by the bulk thermolysis of a phosphoryl-substituted monomer (eq 51)⁵⁵, at 240-290 °C under atmospheric pressure.

The process yields the low molecular weight and high molecular weight polymers but avoids the formation of any cyclic products (eq 52).⁵⁶ When the thermal condensation was carried with trichlorobiphenyl^{56c} as a solvent, and refluxing at 130 °C, polymers with M_w in the range 3×10^4 to 1×10^6 were obtained.

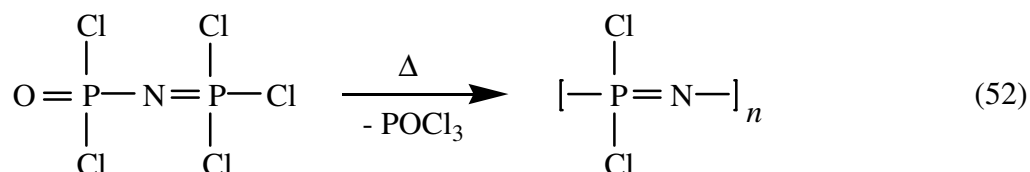
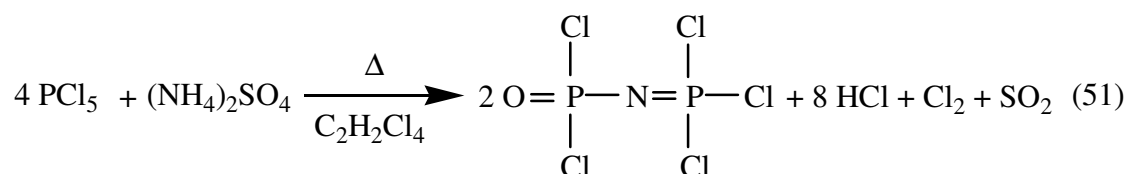

Some low molecular weight polyphosphazenes are obtained from the condensation of phosphinoazide intermediate (eq 53)⁵⁷. Later, Matyjaszewski and co-workers⁵⁸ used this method to prepare polyphosphazenes, including poly(diarylphosphazene), that are not obtained from the condensation of *N*-silylphosphoranimines or from poly(dichlorophosphazene) (eq 54).

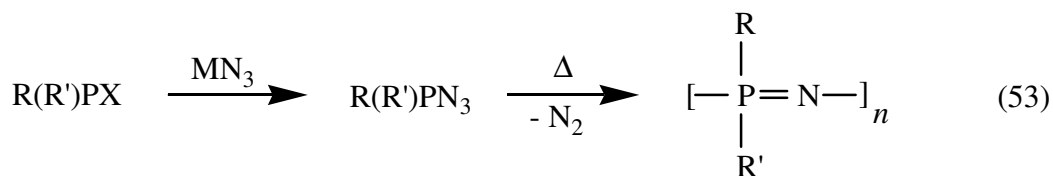

M = Li, Na

R = R' = X = Br

R = R' = Ph, X = Cl

R = Ph, R' = X = Cl

R = R' = Br

R = R' = Ph

R = Ph, R' = Cl

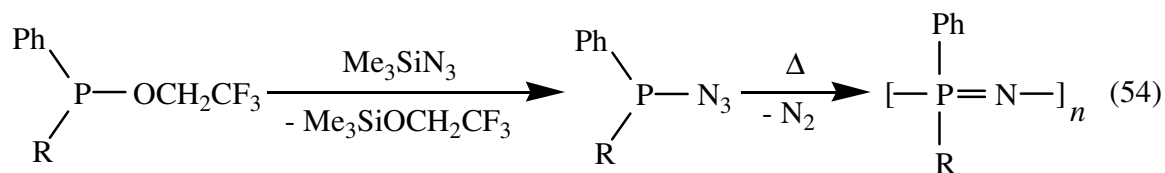

R = OCH₂CF₃, Ph, C₆H₄Me (*o*, *p*)

REACTIVITY OF POLYPHOSPHAZENES

A rich derivative chemistry has been obtained through various substitution reactions at the pendent groups on the phosphorous center of polyphosphazenes. This kind of reactivity is seen in polyphosphazenes, formed by ring-opening polymerization where an organic group is attached through P-O or P-N linkages³ and also in condensation polymerization, where the pendent groups are linked through P-C bonds.⁵ In these processes the polymer backbone is unaffected.

Substitution Reactions at *P*-Alkyl Groups of Polyphosphazenes. A wide variety of new polymers have been synthesized by the deprotonation-substitution reactions at *P*-methyl groups of poly(alkyl/arylphosphazenes). The deprotonation is achieved by the treatment of the polymer with *n*-BuLi at -78 °C. The polymer anion,^{3, 59-67} upon quenching with electrophiles, yields the corresponding substituted polymer. In the case of sterically smaller electrophiles such as methyl iodide (eq 55), the substitution is complete. In contrast, when sterically bulky electrophiles are used, no more than 50 % of the methyl groups are substituted, even when one equivalent of *n*-BuLi is used. The various electrophiles that have been used include inorganic/organic halides,⁵ substituted silyl groups,⁵⁹ carbonyls,⁶⁰ carbon dioxide⁶¹ and esters.⁶²

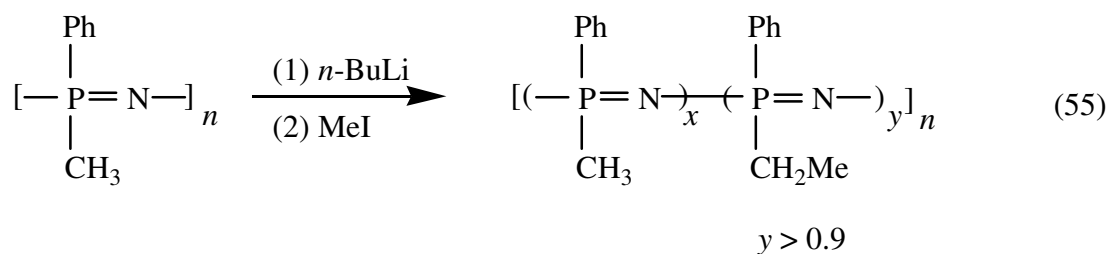

The substituted groups containing reactive vinyl, Si-H, OH, and COOH moieties can be further derivatized (eq 56).⁶³

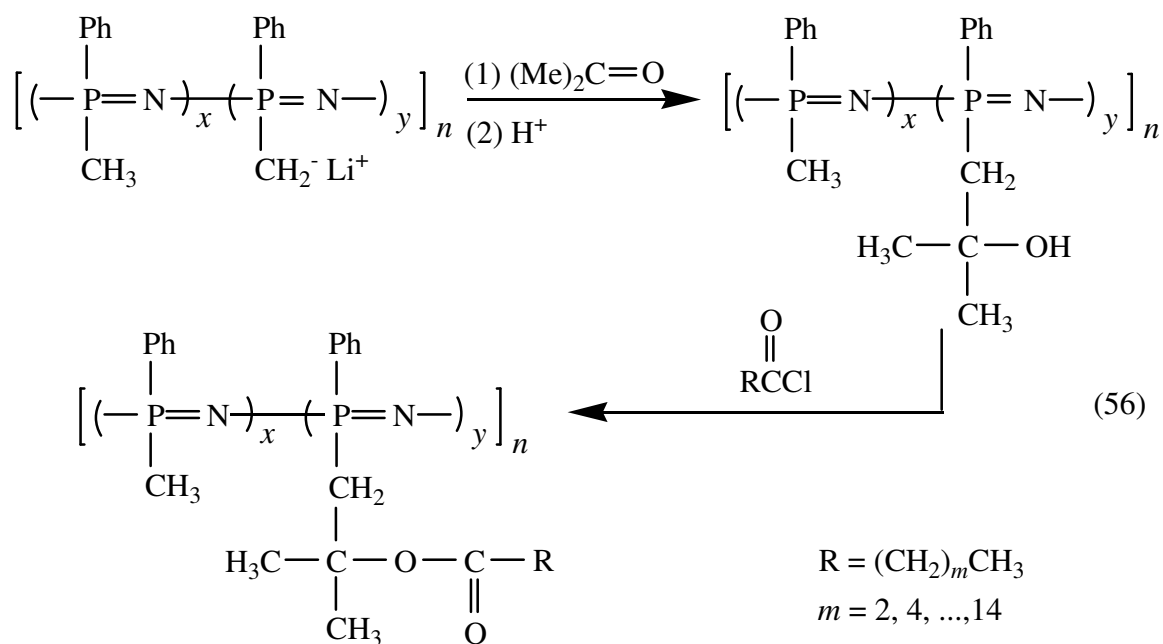

It has also been shown that the polyphosphazene anions can initiate the anionic polymerization of styrene to yield graft copolymers (eq 57)⁶⁴ and also to initiate the ring-opening polymerization of $(\text{Me}_2\text{SiO})_3$ to yield the novel phosphazene-graft-polysiloxane copolymers (eq 58)⁶⁵

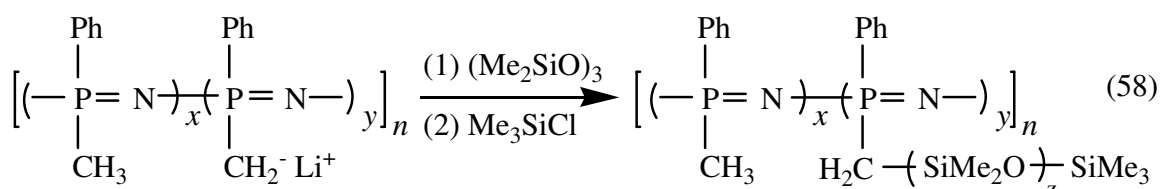
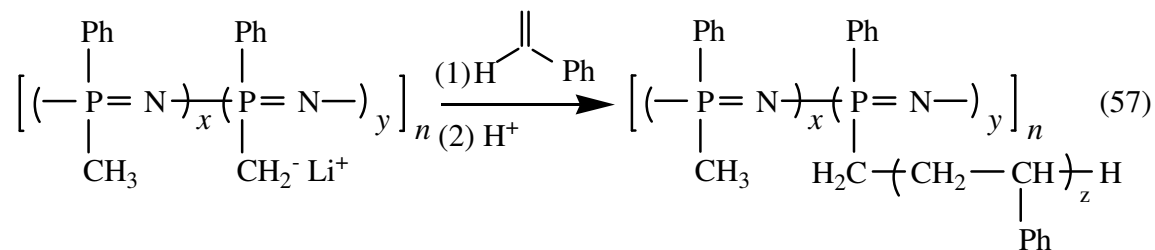

When the deprotonation-substitution reactions⁶⁶ were conducted on polymers with alkyl groups other than methyl groups, it is found that the substitution takes place at the methylene carbon (eq 59). In other cases where both methyl and other alkyl groups are present, the reaction is found to occur at the methyl carbon (eq 60).

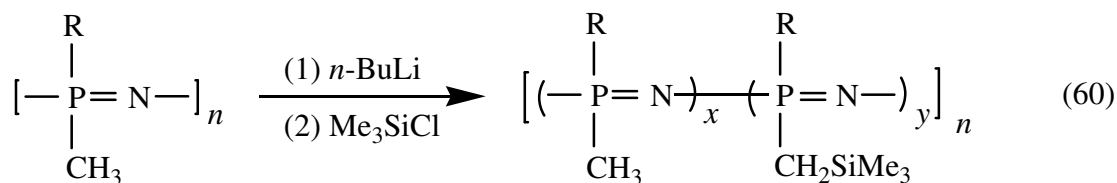
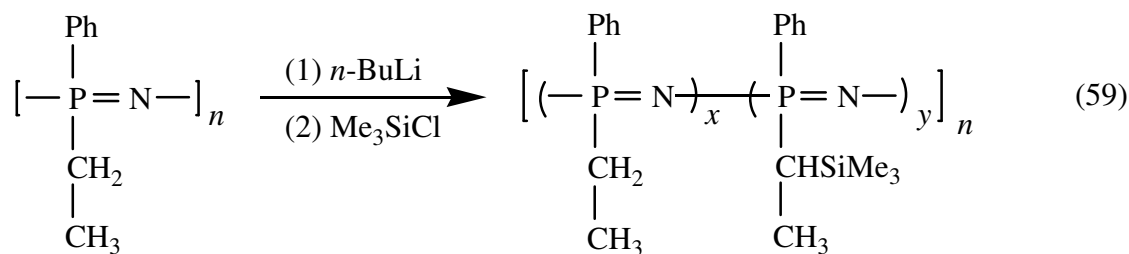

R = *n*-Bu, *n*-Hex

Substitution Reactions at *P*-Phenyl Groups of Polyphosphazenes. The poly(alkyl/arylphosphazenes), when treated with HNO₃ in the presence of H₂SO₄, undergo

nitration of the phenyl ring. The nitration reaction occurs without cleavage of the backbone of the polymer (eq 61).⁶⁸

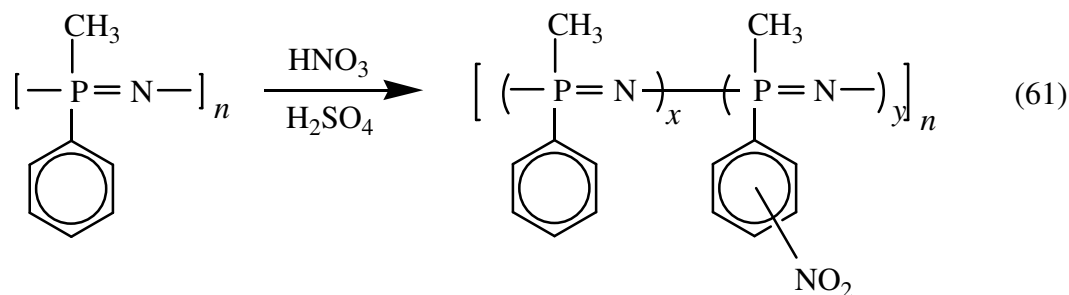

The aryloxy substituted polyphosphazenes also undergo electrophilic substitution reactions such as sulfonation,⁶⁹ and nitration.⁷⁰ The substituted nitro groups can be further derivatized to attach enzymes to the polymer (eq 62).

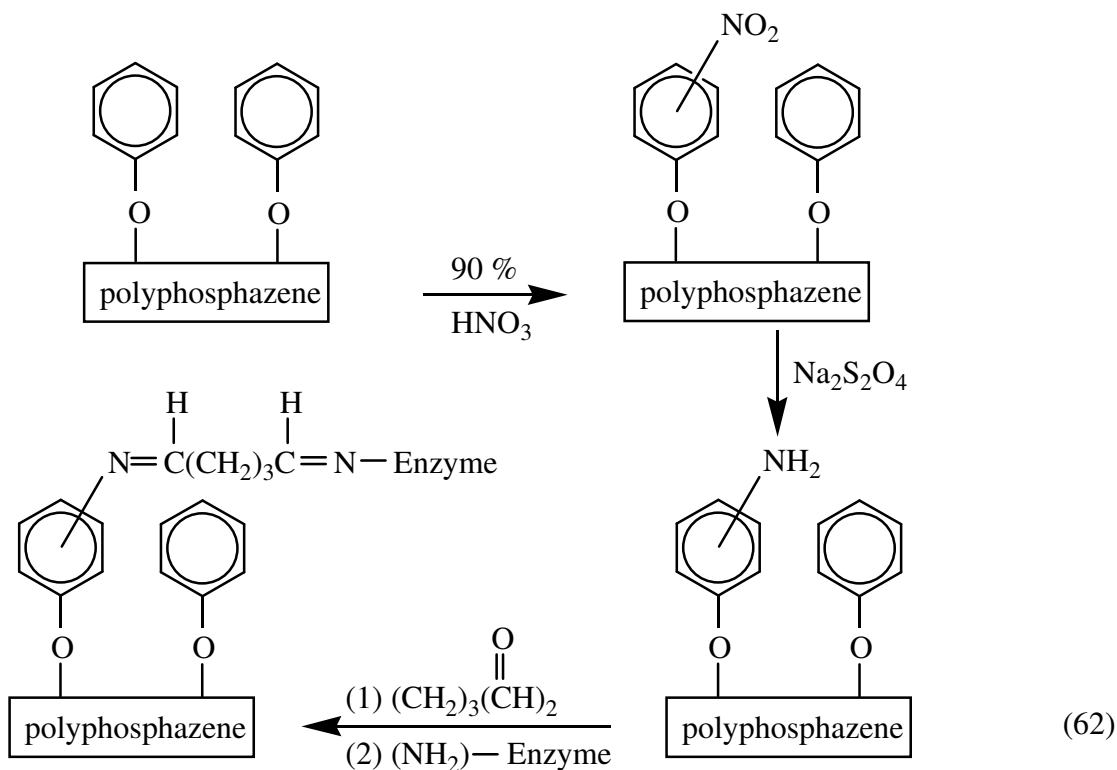

The *P*-haloaryloxy substituted polyphosphazenes can undergo metal-halogen exchange, and can couple to various inorganic halides, phosphines⁷¹ or groups such as (Me₂SiO)₃ can ring-open and form polymers with various

functional groups (eq 63).⁷² The functionalized polymers can be further derivatized by complexing to transition-metal catalysts or chemotherapeutic agents.^{72b}

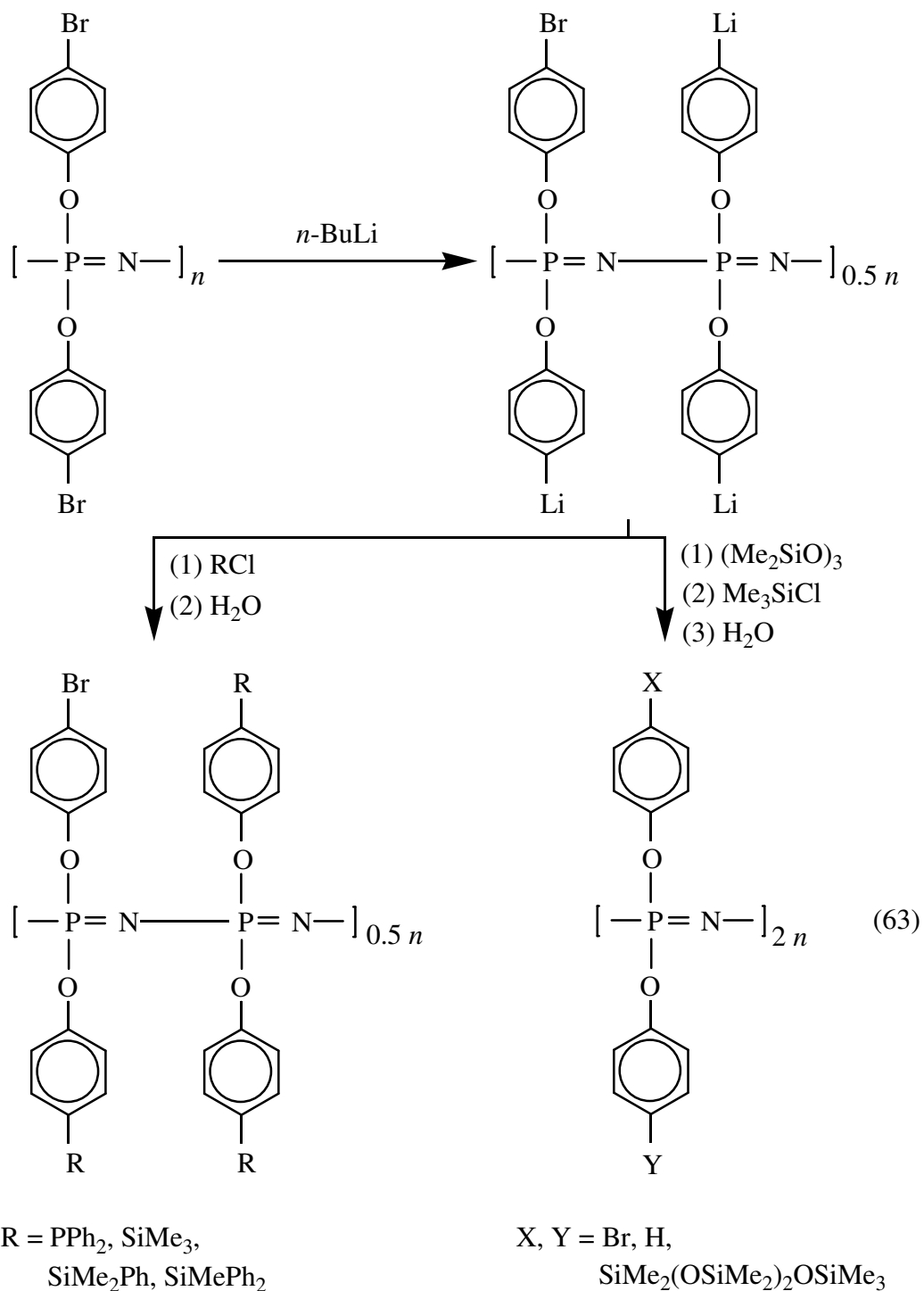

Some metal-halogen exchange reactions have also been studied on the halo-substituted phenyl groups of polyphosphazenes formed by thermal condensation polymerization (eq 64).⁷³

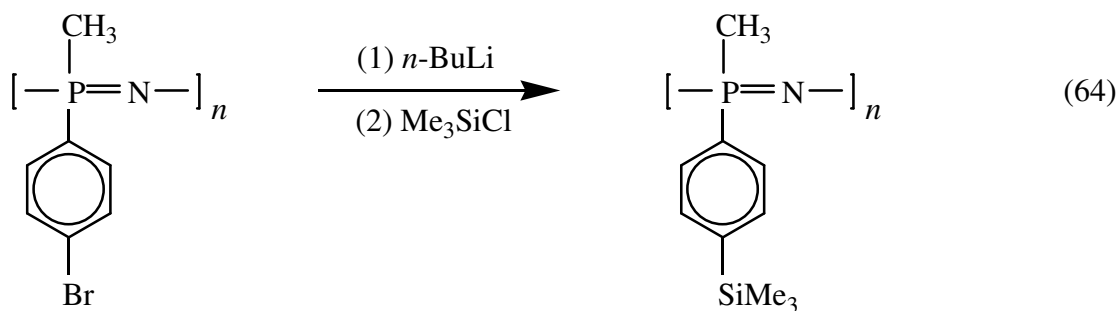

Similar substitution reactions at phenoxy groups have also been studied to produce radicals that can form more thermally stable comb-like graft copolymers (eq 65).⁷⁴

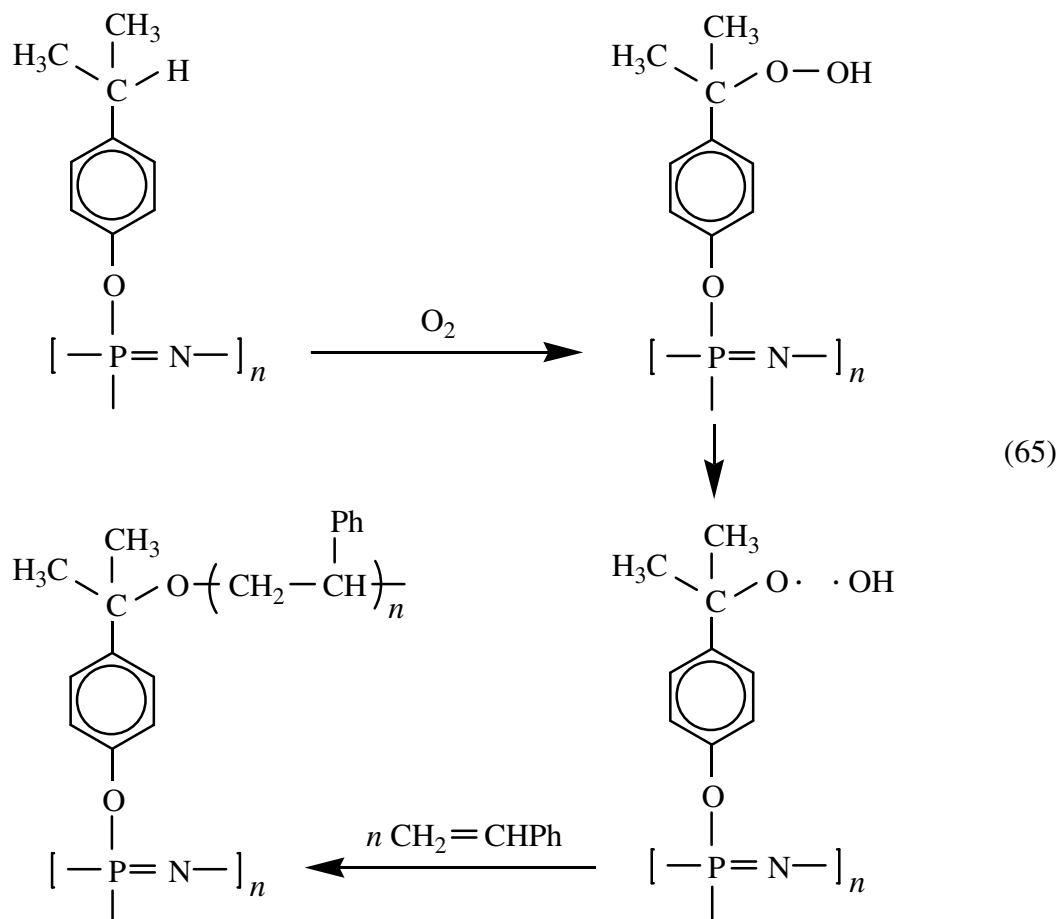

SYNTHESIS OF POLYPHOSPHAZENES CONTAINING SPACER GROUPS.

Depending on the pendent groups at the phosphorous center, polyphosphazenes display a variety of physical and chemical properties. However, by introducing a spacer group into the polymer chain, commercially useful properties such as high glass transition temperature, thermal stability, conductivity etc. can potentially be achieved, while retaining the core advantages of the phosphazene skeleton itself.

Ring-Opening Polymerization. In 1989, Roesky and Lucke, reported the synthesis of hydrolytically stable polyphosphazenes containing transition metals in the polymer chain (eq 66).⁷⁵ These new polymers find applications as electronic materials and ceramic precursors.

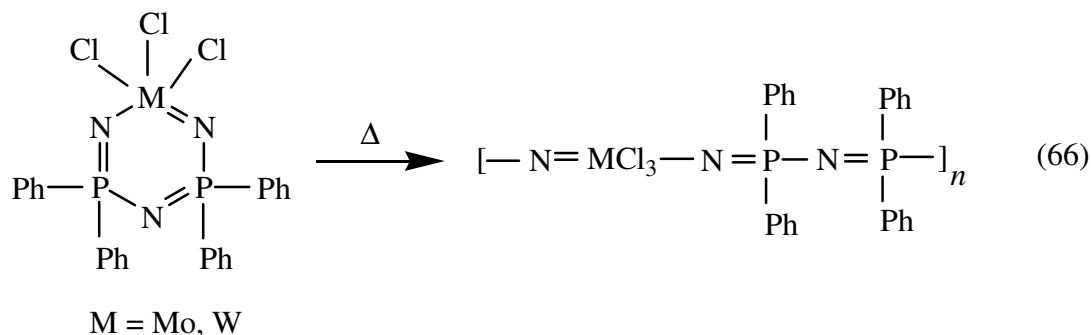

Allcock and co-workers have synthesized polyphosphazenes with either carbon (polycarbophosphazenes) (eq 67)⁷⁶ or sulfur (polythiophosphazenes) (eq 68)⁷⁷ as spacer groups by the ring-opening polymerization of cyclocarbophosphazenes and cyclothiophosphazenes, respectively. Due to the reduction of torsional mobility of the polymer chains, the glass transition temperatures (T_g) of the polycarbophosphazenes are

observed to be higher than that of analogous polyphosphazenes, while the T_g of poly(thiophosphazenes) ranges between the values of polyphosphazenes and poly(carbophosphazenes) with similar side groups.

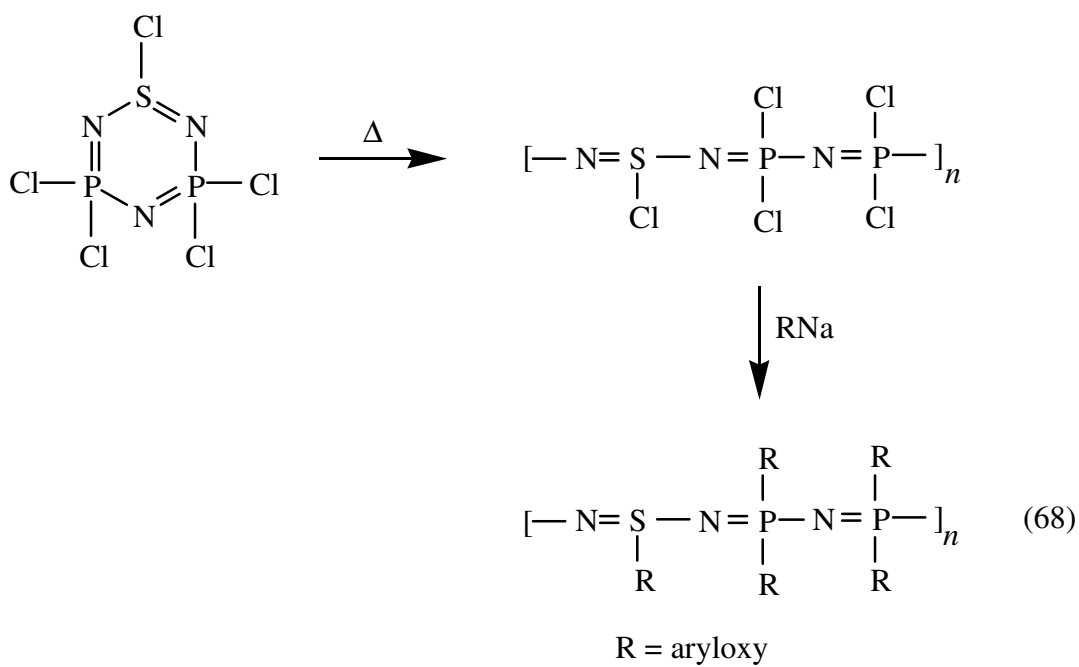
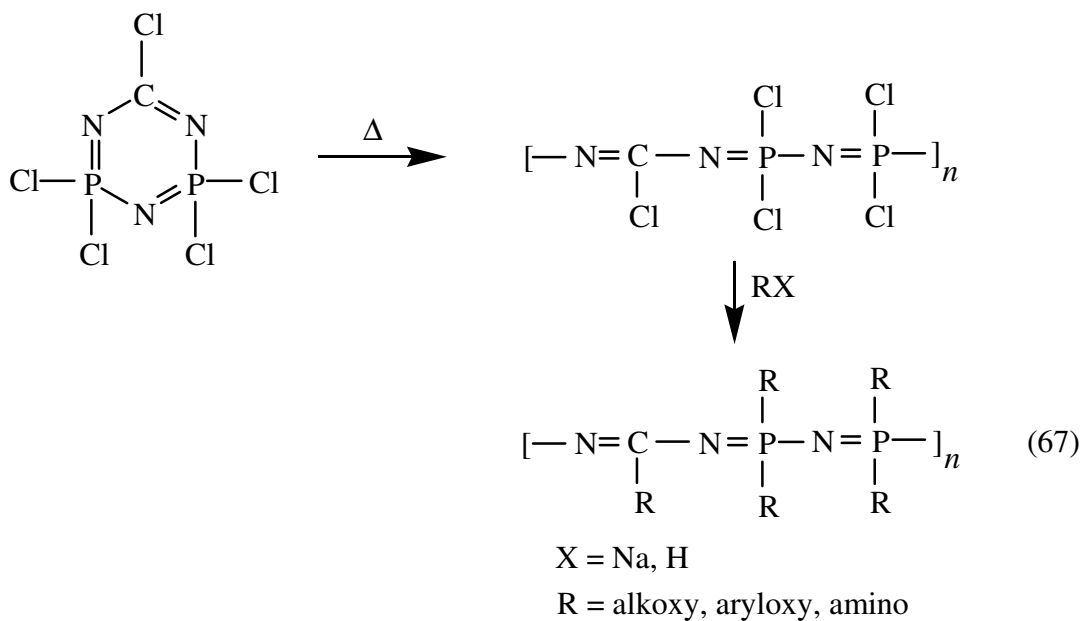

The ring-opening polymerization of cyclic thionylphosphazenes has yielded poly(chlorothionylphosphazenes). Subsequent nucleophilic substitution of chlorine preferentially takes place at the phosphorous atoms only. Unlike in polyphosphazenes, poly(carbophosphazenes), and poly(thiophosphazenes), the S-Cl bond in poly(thionylphosphazenes) is hydrolytically stable and cannot be replaced by aryloxy and alkoxy groups. However, amino groups can substitute the chlorine atoms to form amino substituted poly(thionylphosphazenes) (eq 69).⁷⁸

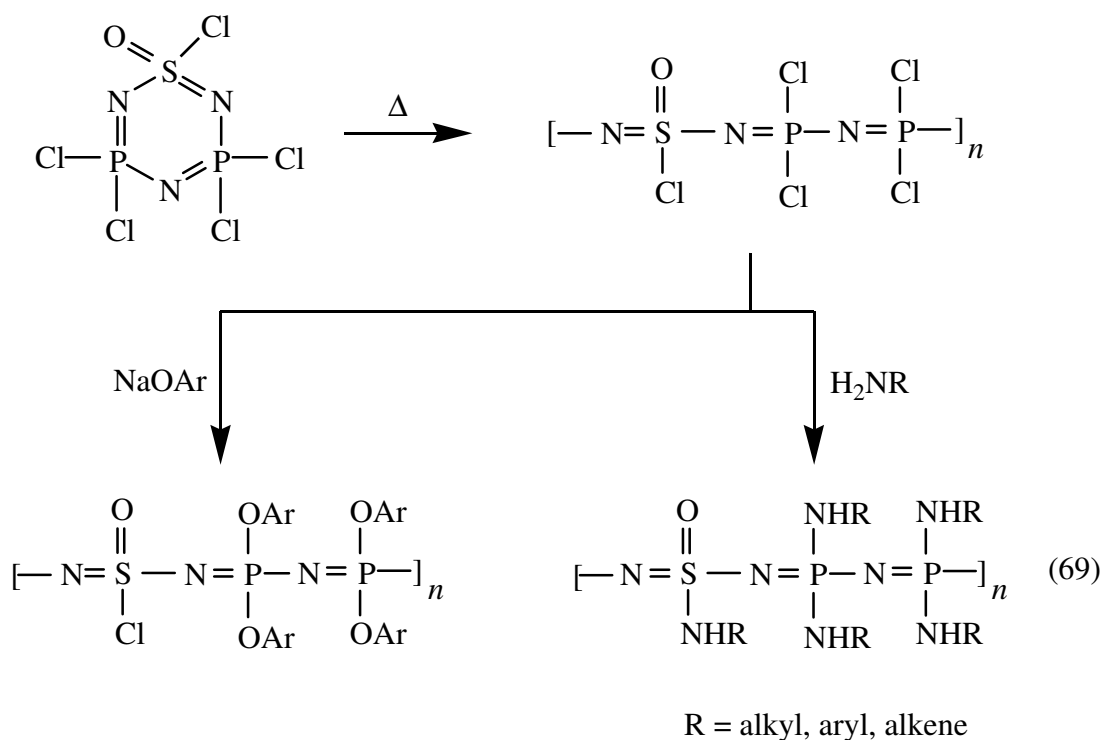

Poly(thionylphosphazenes) and their derivatives, poly(thionylphosphazene)-*b*-poly(tetrahydrofuran) block copolymers find applications as potential candidates as phosphorescent oxygen matrices (eq 70).⁷⁹

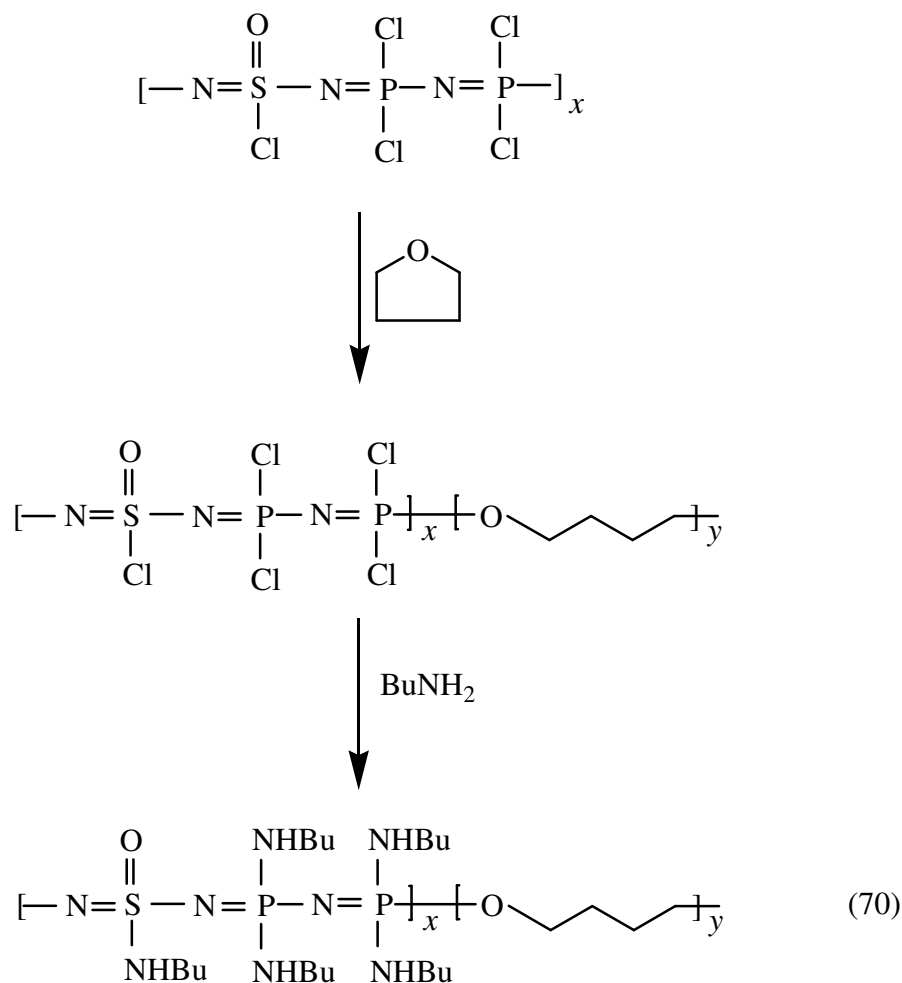

Condensation Polymerization. The condensation polymerization process is the preferred method for the synthesis of fully alkyl/aryl substituted polyphosphazenes with a spacer group in the polymer chain. When an *N*-silylphosphoranimine is copolymerized with an *N*-silylsulfonamide,⁸⁰ a monomeric thionylphosphazene is formed. Thionylphosphazene monomer, on thermal condensation, directly yields poly(thionylphosphazene). The monomer can also be protonated and then polymerized to poly(thionylphosphazene) at lower temperature (eq 71).⁸¹

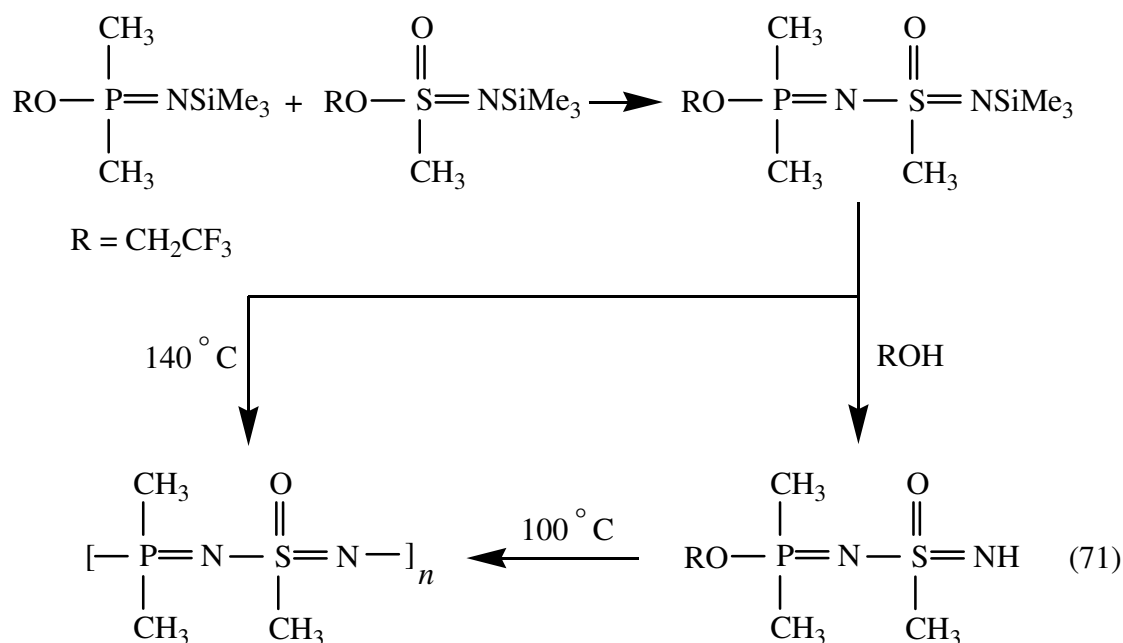

Poly(thiazylphosphazenes), hybrids of poly(sulfur nitride) and polyphosphazenes, have also been reported (eq 72).⁸²

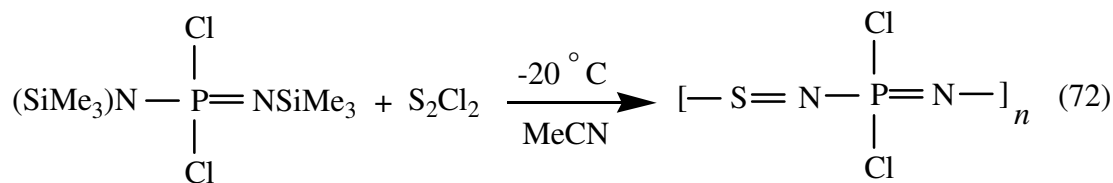

The Staudinger reaction between a diazide and a diphosphine affords low molecular weight polyphosphazenes, where a phenyl group alternates with the P=N groups (eq 73).¹¹

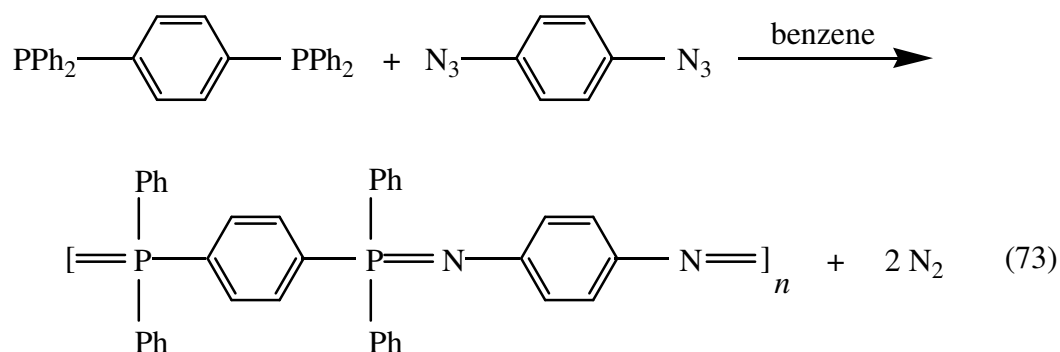

Oligomers with alkyl/aryl spacer groups were also synthesized. These materials have molecular weights in the range 1,800 – 3,600 with T_g values ranging from 100 – 300 °C (eq 74).¹² Other types of polyphosphazenes with silane,^{83a} phosphazene,^{83b} dithiodiazadiphosphetidine,^{83c} and decaborane^{83d} groups as spacers in the chain have also been synthesized.

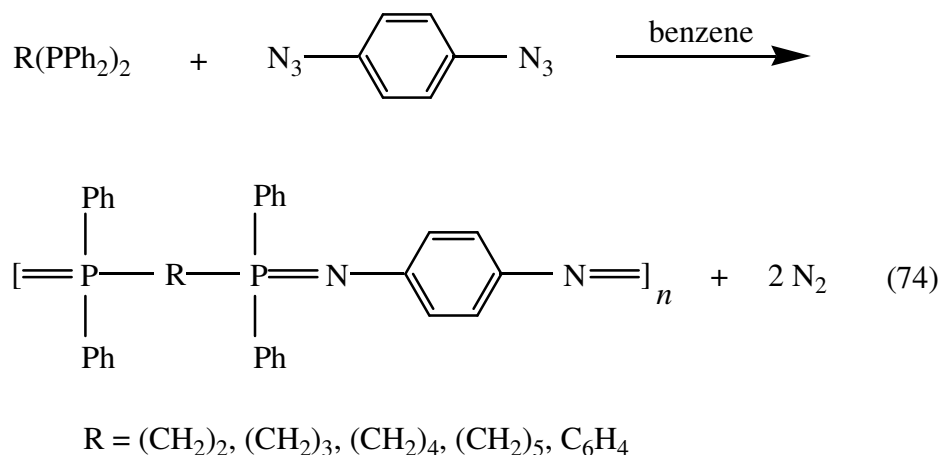

CONCLUSIONS

The chemistry of polyphosphazenes and their derivatives has gained significance in the scientific community. Depending on the substituents, these materials exhibit a wide variety of chemical and physical properties and are potential candidates for many applications. Synthetically, the desired substituents can be introduced at either the monomer stage or the polymer stage.

In the condensation polymerization, polyphosphazenes are often synthesized by the thermal condensation of suitably substituted phosphoranimines, which in turn are accessible via the oxidation reactions of (silylamino)phosphines. This dissertation will

describe the synthesis and reactivity of various types of (silylanilino)phosphines that can be eventually converted to novel phosphazene materials having desirable properties.

This dissertation also presents the synthesis and reactivity of some related (silylamino)(silylanilino)phosphines. The oxidation reactions of these phosphines have yielded the corresponding phosphoranimines. The phosphoranimines undergo thermal condensation to form insoluble cross-linked polymers or linear phosphazene polymers containing N-silyl functional groups.

As a part of our ongoing efforts to synthesize well characterizable poly(phenylenephosphazenes), some non-geminal (disilylanilino)phosphines that may eventually be oxidized to yield novel poly(phenylenephosphazenes) have been synthesized. The synthesis of these phosphines is also described in this dissertation.

SECTION ONE

SYNTHESIS AND REACTIVITY OF (SILYLANILINO)PHOSPHINES

Introduction

Poly(carbophosphazenes), poly(thiophosphazenes), poly(thionylphosphazenes) are some of the well-characterized phosphazene copolymers containing spacer groups in the P-N polymer backbone. These materials were either synthesized from the ring-opening polymerization of suitable cyclic triphosphazene analogs or from the condensation reactions of suitable phosphoranimine precursors. Some examples of polyphosphazenes containing phenylene as the spacer group, synthesized by the Staudinger reaction, have also been reported. Although preliminary investigations by the Neilson group have focused on some poly(phenylenephosphazenes), fully characterizable materials have not yet been obtained. In this section, we report the synthesis of a series of (silylanilino)phosphines. These novel phosphines display three kinds of reaction sites, similar to the traditional (silylamino)phosphines. The reactivity of these compounds and some preliminary studies towards the formation of poly(phenylenephosphazenes) are also presented.

Results and Discussion

Synthesis of (Silylanilino)phosphines. The required silylaniline reagents **A - D** (eq 1) were synthesized in good yields from *p*-bromoaniline. When *p*-bromoaniline was treated with one equivalent of an organolithium reagent, followed by chlorotrimethylsilane, the *N*-monosilylated compound **A** is produced. Compound **A**, on reacting with one

equivalent organolithium reagent, followed by addition of the trimethylsilyl group, forms the *N*-disilylated compound **B**. Compound **C** is synthesized by the metal-halogen exchange of compound **B** with the organolithium reagent, and then by substituting lithium with a trimethylsilyl group. The N-Si bond cleavage reaction of compound **C**, using dry HCl, yields the *N*-monosilylated compound **D**.

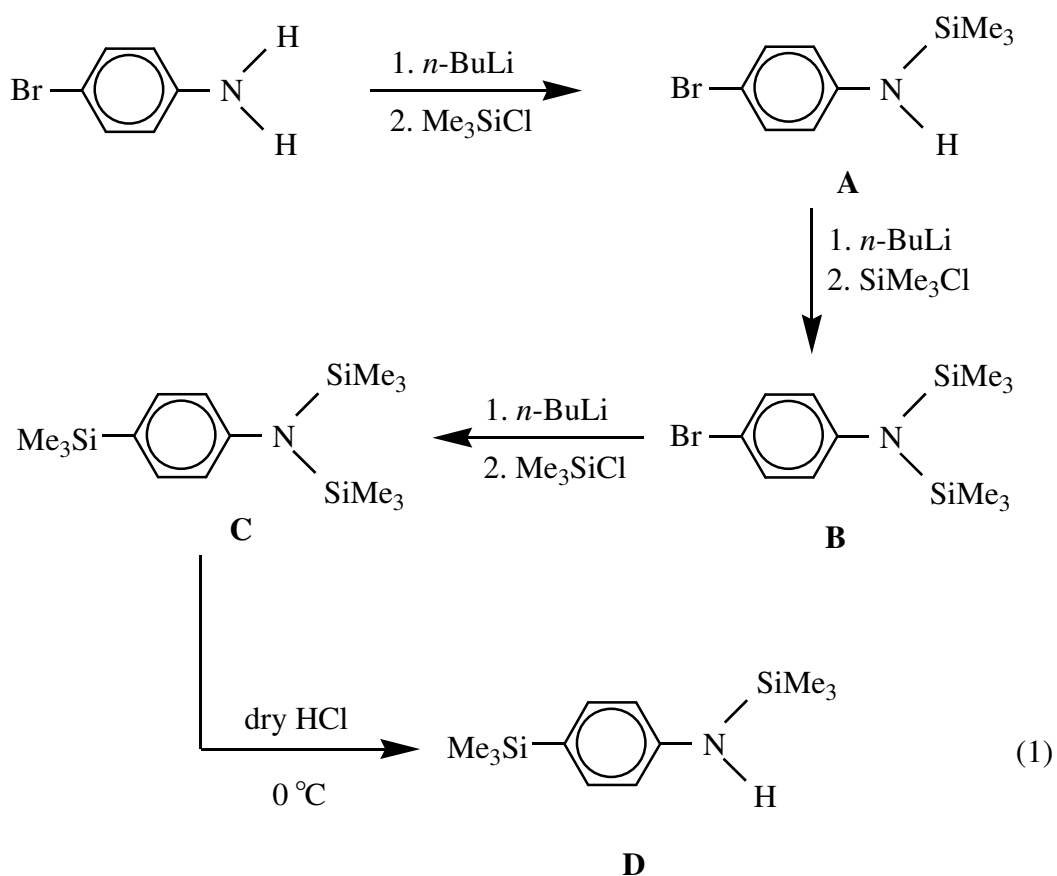

The compounds **A - D** are moisture sensitive, colorless to light yellow colored, distillable liquids. Compound **A** solidifies when cooled slightly below room temperature. Some N-Si bond cleavage reactions of compound **C** with reagents including *n*-BuLi (eq 2), CF₃CH₂OH (eq 3), and chlorophosphines (eq 4) were attempted but did not yield the

desired products. The new compounds **C** and **D** were characterized by ^1H and ^{13}C NMR spectroscopy (Table 1) and by elemental analysis (Table 7).

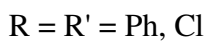
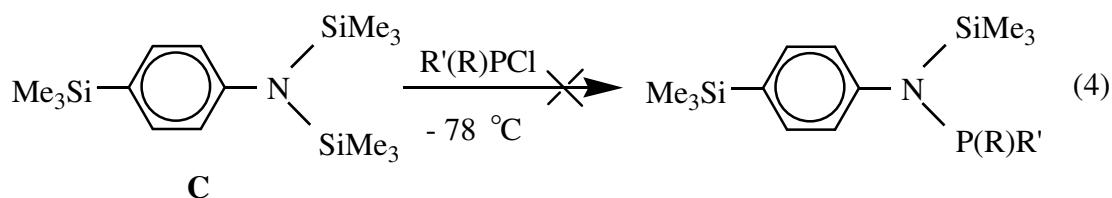
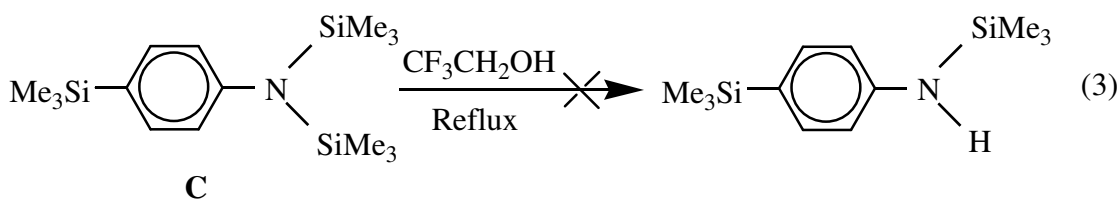
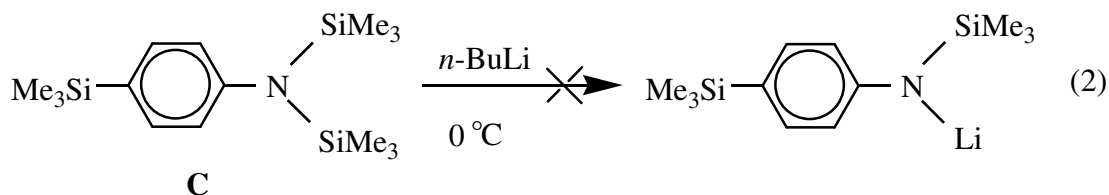

In a process based on the Wilburn method,¹⁵ the N-lithiated derivatives of compounds **A** and **D** were treated with chlorophosphines. Nucleophilic substitution at the remaining P-Cl center produced the new (silylanilino)phosphines **1 - 12** (eq 5, 6).

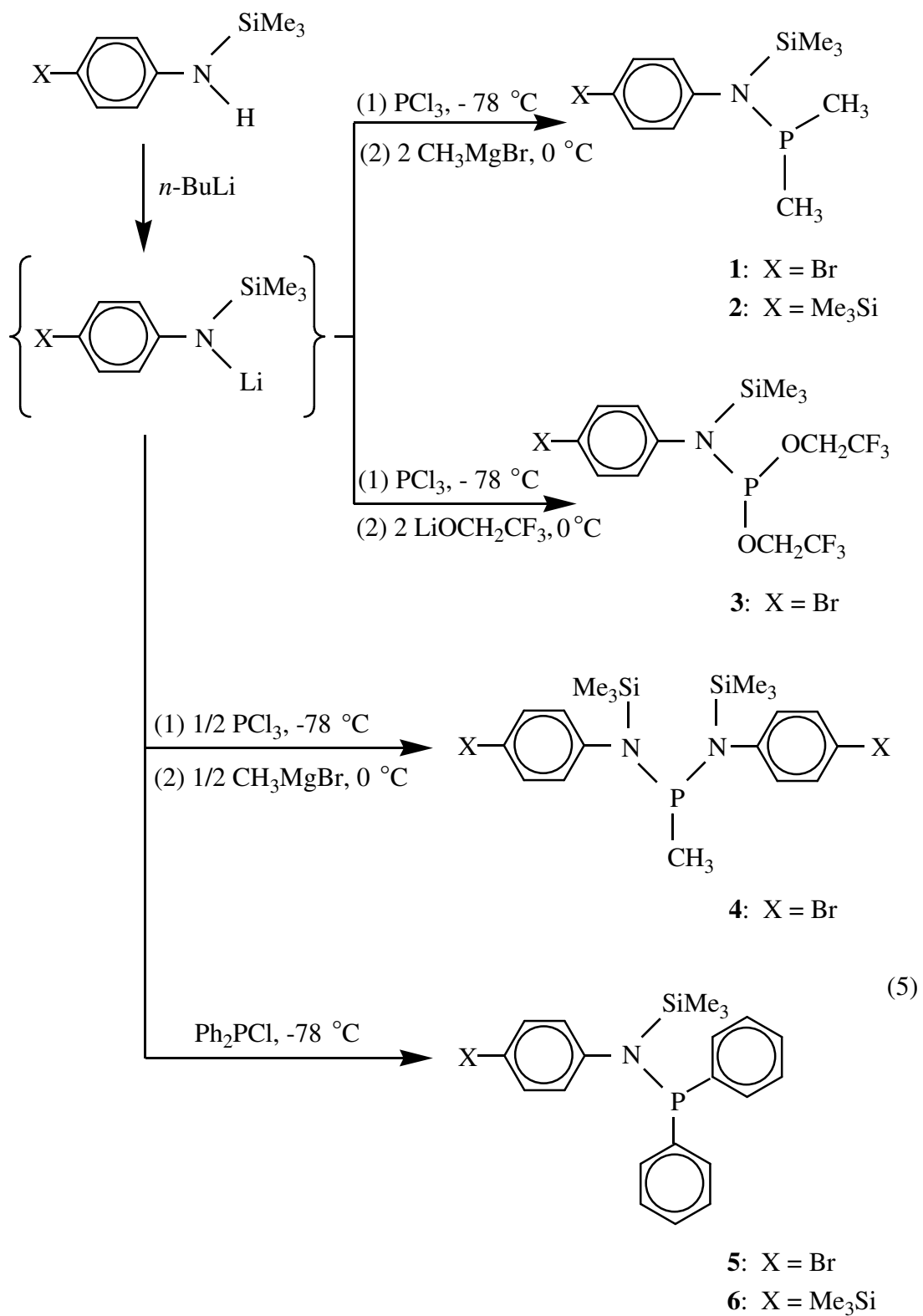

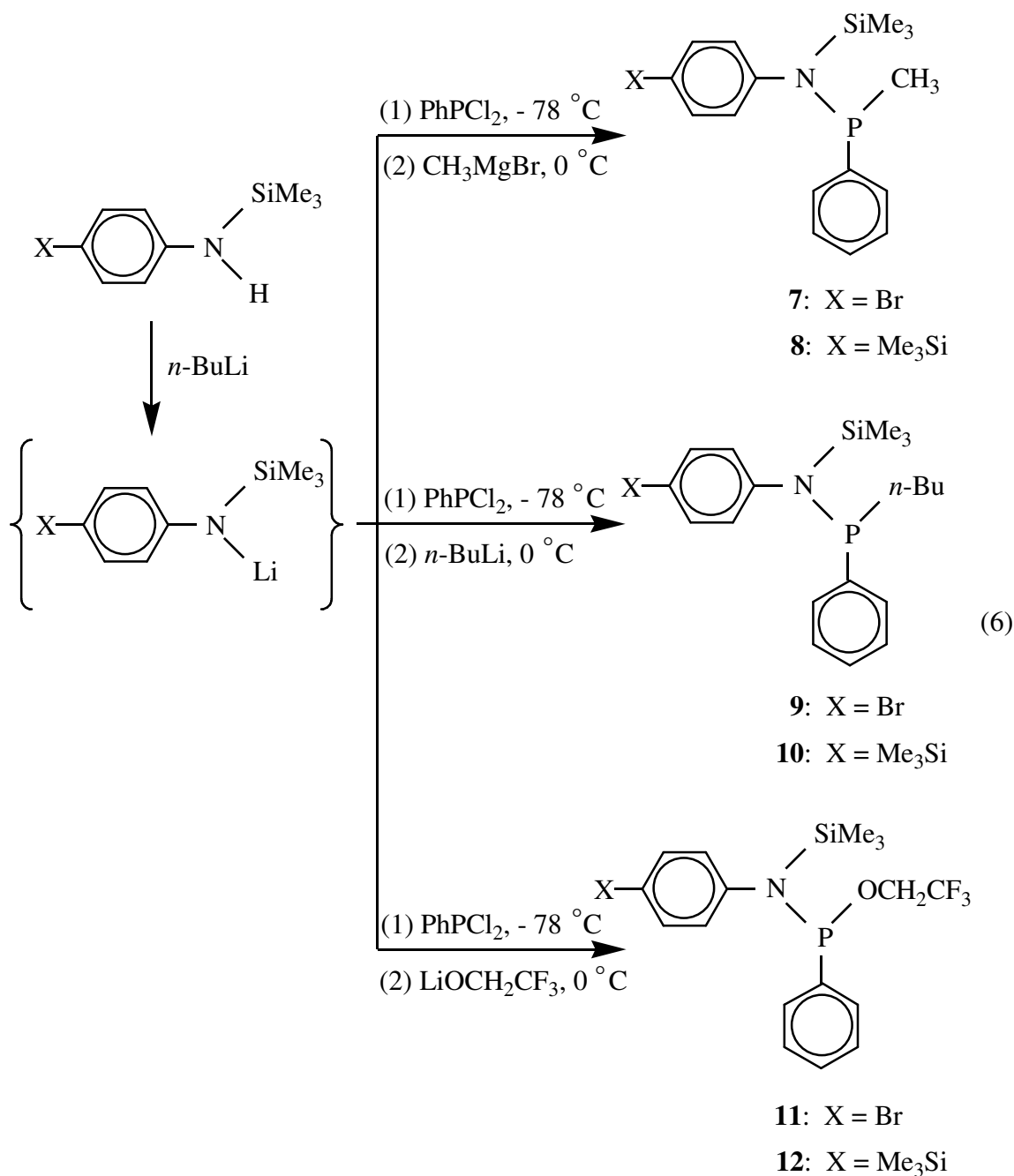

Compounds **1 – 12** are air/moisture-sensitive liquids or low-melting solids that were purified by long path vacuum distillation. Compounds **1 – 3**, **7**, and **9 – 12** were distilled as colorless liquids. Compound **4** was obtained as a colorless gel, compound **5** as a white solid, compound **6** as a pale yellow gel, and compound **8** as a white wax-like

material. Phosphines **1** – **12** were fully characterized by ^1H , ^{13}C , and ^{31}P NMR spectroscopy (Table 2) and by elemental analysis (Table 7).

Staudinger Reactions of (Silylanilino)phosphines. A series of phosphoranimines were synthesized by using the Staudinger reaction. When the novel (silylanilino)-phosphines were refluxed for 72 hrs, with an excess of trimethylsilylazide, in the absence of solvent, the corresponding phosphoranimines **13** – **17** were obtained in high yields (eq 7).

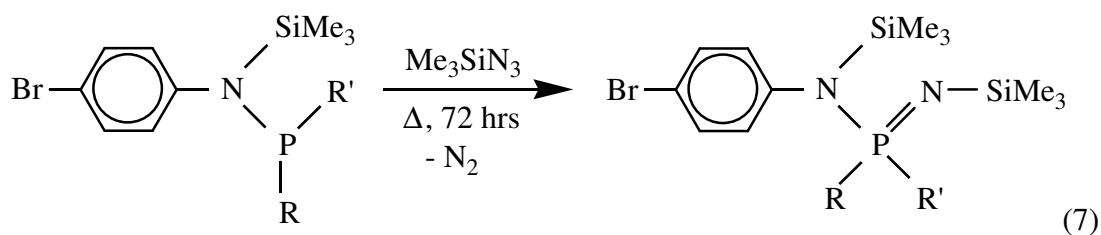

- | | |
|--|--|
| 1: R = R' = CH ₃ | 13: R = R' = CH ₃ |
| 3: R = R' = OCH ₂ CF ₃ | 14: R = R' = OCH ₂ CF ₃ |
| 7: R = Ph, R' = CH ₃ | 15: R = Ph, R' = CH ₃ |
| 9: R = Ph, R' = <i>n</i> -Bu | 16: R = Ph, R' = <i>n</i> -Bu |
| 11: R = Ph, R' = OCH ₂ CF ₃ | 17: R = Ph, R' = OCH ₂ CF ₃ |

The phosphoranimines **13** – **17** are air/moisture sensitive compounds that were purified by long path vacuum distillation. Compound **13** is a white crystalline solid, compounds **14** and **15** are colorless liquids and compounds **16** and **17** distilled as colorless gels. These phosphoranimines were fully characterized by ^1H , ^{13}C , ^{31}P NMR spectroscopy (Table 3) and by elemental analysis (Table 7).

Reactions of (Silylanilino)phosphines with MeI. When phosphines **1** and **7** were allowed to react with MeI and subsequently treated with MeLi or *n*-BuLi, mixtures of products such as **18** and **20**, or **19** and **21** were obtained (eq 8). Even after repeated

distillations, the desired compounds **18**, **19** were not completely separable from the disilylated products **20** and **21**, respectively.

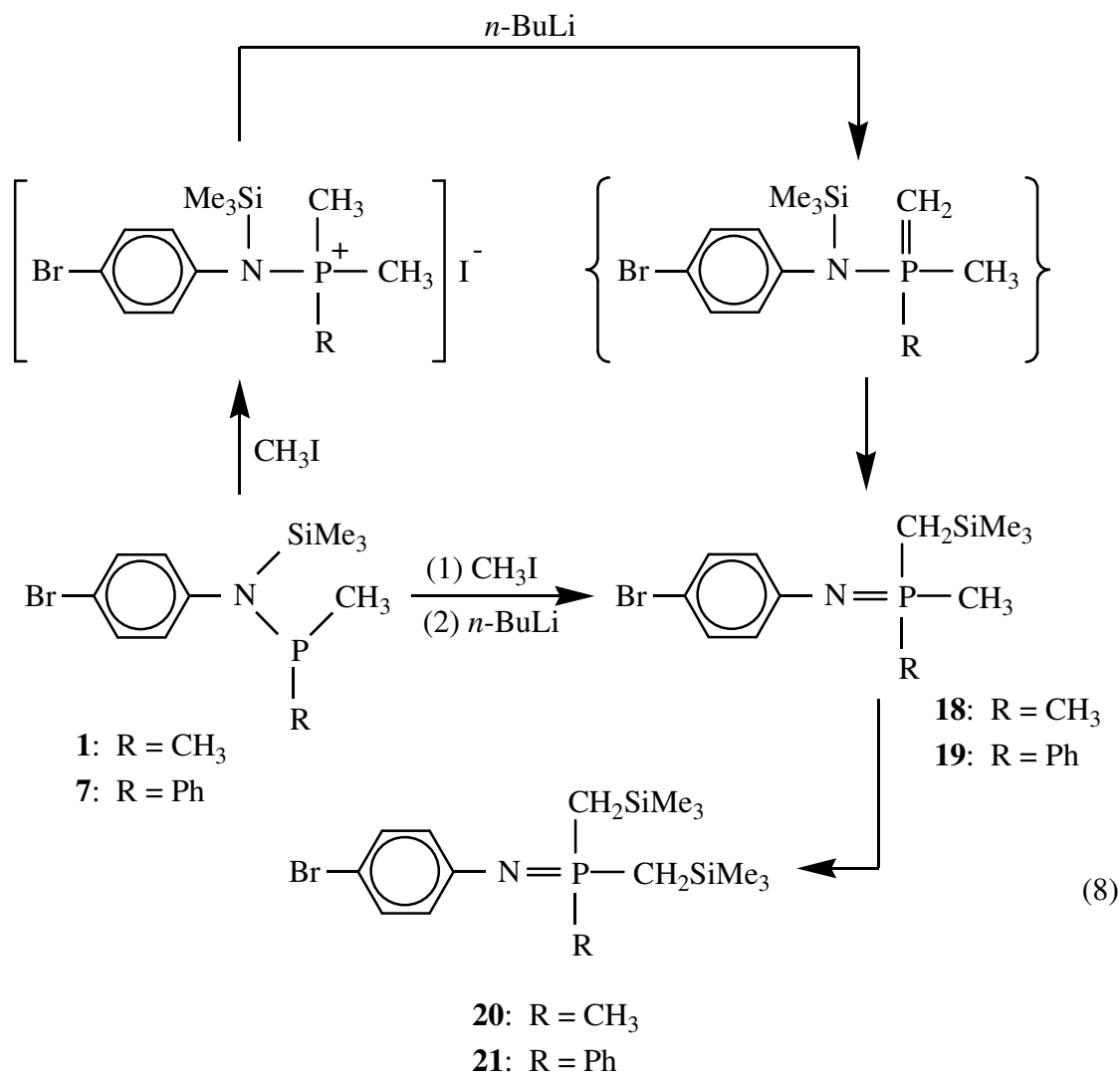

We propose that the initial addition of MeI to the phosphine resulted in formation of a phosphonium salt. Subsequent addition of *n*-BuLi results in deprotonation, followed by a [1, 3]-silyl shift to yield products **18** and **19**. A small percentage of these products undergo further deprotonation-substitution at the second methyl group to yield compounds **20** and **21**. Mixtures of compounds **18**, **20** and **19**, **21** are dark red colored liquids, that

were obtained by long path vacuum distillation. These phosphoranimines were tentatively identified by ^1H , ^{13}C , ^{31}P NMR spectroscopy (Table 4). Compounds **18** ($[\text{M}]^+$ calcd. 318.27, found 318.00) and **20** ($[\text{M}]^+$ calcd. 390.45, found 390.00) were also characterized by mass spectroscopy.

Oxidative Bromination Reactions. Oxidation of (silylanilino)phosphines **1**, **3**, **7** – **9**, **11**, **12** ($\text{X} = \text{Br}$) was performed by using Br_2 as reagent. The addition of one equivalent of Br_2 to the phosphine in benzene solution, resulted in the elimination of BrSiMe_3 and formation of an intermediate P-Br derivative **E** (eq 9). Nucleophilic substitution of the P-Br groups with $\text{LiOCH}_2\text{CF}_3$ afforded the phosphoranimines **22** – **28** (eq 9). Similar reactions of phosphines **8** and **12** ($\text{X} = \text{SiMe}_3$) produced phosphoranimines **24** and **27** along with phosphoranimines **25** and **28**. Even after repeated distillations, mixtures of these phosphoranimines could not be separated. We presume that the C-trimethylsilyl group in **8** and **12** is susceptible to cleavage in the bromination reaction and thus substituted with bromine. This susceptibility of C–Si bond cleavage of phosphoranimines may open a new avenue for the synthesis of poly(phenylenephosphazenes) by condensation polymerization. The compounds **22** – **28** were characterized by ^1H , ^{13}C , ^{31}P NMR (Table 5) and compounds **22** – **24**, **26**, **27** (Table 7) gave acceptable elemental analyses.

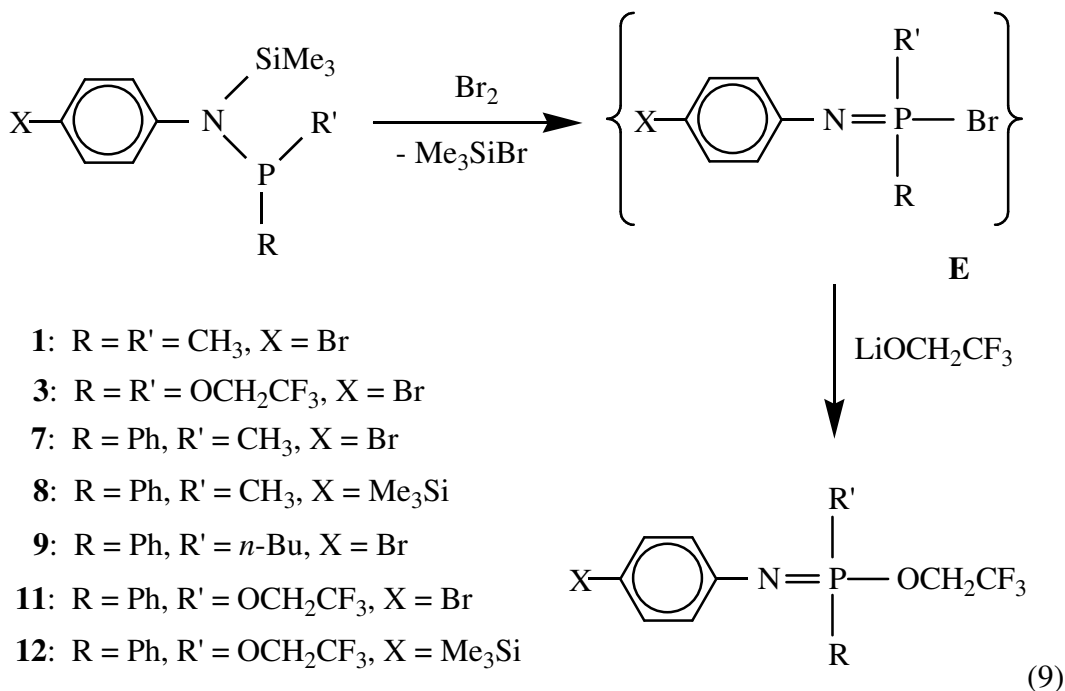

- 22:** R = R' = CH₃, X = Br
23: R = R' = OCH₂CF₃, X = Br
24: R = Ph, R' = CH₃, X = Br
25: R = Ph, R' = CH₃, X = Me₃Si
26: R = Ph, R' = *n*-Bu, X = Br
27: R = Ph, R' = OCH₂CF₃, X = Br
28: R = Ph, R' = OCH₂CF₃, X = Me₃Si

Metal-Halogen Exchange of Phosphoranimine 23. When treated with two equivalents of *t*-BuLi at $-78\text{ }^{\circ}\text{C}$, phosphoranimine **23** underwent metal-halogen exchange at the *p*-Br position of the aryl ring. Addition of Me₃SiCl afforded the *p*-trimethylsilyl substituted phosphoranimine **29** (eq 10). The metal-halogen exchange reaction is not complete and a major amount of the reactant **23** remained. It was not possible to purify compound **29**, even by repeated distillations. Compound **29** was identified by ¹H, ¹³C, and ³¹P NMR spectroscopy (Table 5).

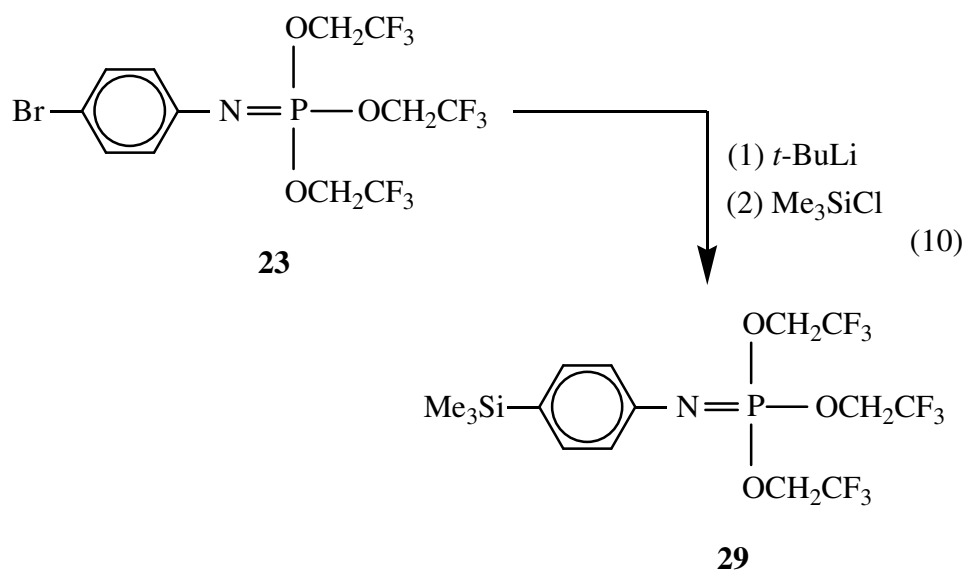

Thermolysis of Phosphoranimines. *N*-silylphosphoranimines **14** and **17** underwent thermal condensation to form polyphosphazenes **30** and **31** respectively (eq 11). The condensation process was carried out by sealing the phosphoranimines in thick walled glass ampules under high vacuum and heating at 200 °C for approximately two weeks. The ampules were opened and the volatile silyl ether was collected in a cold trap and identified by ^1H NMR. The condensed products were readily soluble in CH_2Cl_2 and CHCl_3 . The formation of these phosphazene materials is indicated by ^1H , ^{13}C , ^{31}P NMR spectroscopy (Table 6). Molecular weight measurement and other property studies of these materials have not yet been performed.

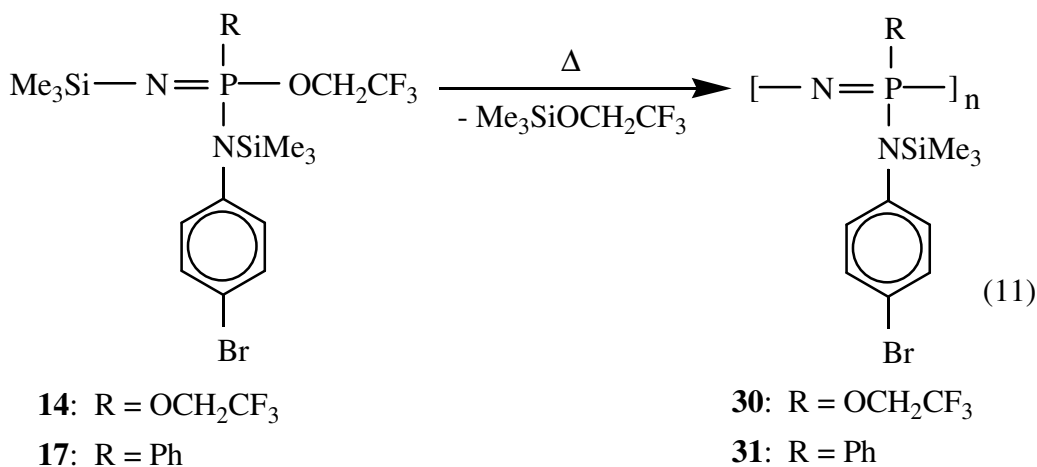

EXPERIMENTAL

Materials and general procedures. The following reagents were obtained from commercial sources and used without further purification: PCl_3 , PhPCl_2 , Ph_2PCl , *p*- $\text{BrC}_6\text{H}_4\text{NH}_2$, Me_3SiN_3 , Me_3SiCl , CH_3I , CCl_4 , Br_2 , $\text{CF}_3\text{CH}_2\text{OH}$, HCl (1 M in ether), CH_3MgBr (3.0 M in ether), CH_3Li (1.6 M in ether), *n*-BuLi (2.5 M in hexane), and *t*-BuLi (1.7 M in pentane). The solvents Et_2O and hexane were distilled under N_2 from CaH_2 , the solvents CH_2Cl_2 and benzene were distilled under Argon from CaH_2 immediately prior to use. Proton, $^{13}\text{C}\{^1\text{H}\}$, and $^{31}\text{P}\{^1\text{H}\}$ NMR spectra were recorded on a Varian XL-300 spectrometer using CDCl_3 as a solvent. Elemental analysis were performed by Schwarzkopf Microanalytical laboratory, Inc, New York. Mass spectroscopy was performed on a Hewlett Packard 5989A mass spectrometer with 5890 Series II gas chromatograph. All the reactions and other manipulations were carried out under dry nitrogen or under vacuum unless otherwise specified.

Preparation of Silylaniline Reagent A. A 3-neck, 3000 mL, round-bottom flask, equipped with a mechanical stirrer, an N_2 inlet, rubber septum and an additional funnel, was charged with Et_2O (1500 mL) and $\text{BrC}_6\text{H}_4\text{NH}_2$ (172.03 g, 1000 mmol). The mixture was cooled to 0 °C and *n*-BuLi (430 mL, 1075 mmol) was added slowly via additional funnel. After the addition, the reaction mixture was allowed to warm to room temperature and was stirred for one hour. The mixture was again cooled to 0 °C and Me_3SiCl (126.5 mL, 1000 mmol) was added slowly. The mixture was allowed to warm to room temperature and was stirred for five hours. Ether was removed under reduced pressure and hexane (600 mL) was added to precipitate the salt. The salt was removed by filtration and

the filtrate was collected. The solvents were removed under reduced pressure and the product was distilled at 66-70 °C (0.01 mmHg) as a pale yellow liquid, that turns to a solid on standing at room temperature. The compound was stored under N₂ atmosphere.

Preparation of Silylaniline Reagent B. The procedure for the preparation of silylaniline reagent **B** was slightly modified from the reported literature procedure.⁸⁴ A 3-neck 2000 mL, round-bottom flask, equipped with a mechanical stirrer, an N₂ inlet, a rubber septum, and an additional funnel, was charged with Et₂O (600 mL) and compound **A** (73.2 g, 300 mmol). The mixture was cooled to 0 °C and *n*-BuLi (120 mL, 300 mmol) was added slowly. The mixture was allowed to warm to room temperature and was stirred for one hour. Ether was removed under reduced pressure and hexane (1000 mL) was added. The mixture was again cooled to 0 °C and Me₃SiCl (350 mmol) was added slowly. The mixture was then refluxed for 8 hour, and the salt was allowed to settle and the supernatant solution was removed by cannula. The solvent was removed under reduced pressure and the product was distilled at 67-70 °C (0.01 mmHg) as a colorless to pale yellow colored liquid. The compound was stored under N₂ atmosphere.

Preparation of Silylaniline Reagent C. The aniline analog **C** was prepared in a similar way as compound **A**, except compound **B** was used instead of BrC₆H₄NH₂. The product was distilled at 55-65 °C (0.01 mmHg) as a colorless liquid. The compound was stored under N₂ atmosphere.

Preparation of Silylaniline Reagent D. A 3-neck 1000 mL, round-bottom flask, equipped with a mechanical stirrer, an N₂ inlet, a rubber septum, and an additional funnel, was charged with Et₂O (600 mL) and compound **C** (62 g, 200 mmol). The mixture was

cooled to 0 °C and HCl (150 mL, 150 mmol) was added drop wise. After completion of addition, the mixture was stirred at 0 °C for about four hours. Ether was removed under reduced pressure and hexane (200 mL) was added to precipitate the salt. The salt was removed by filtration and the product was distilled at 65-71 °C (0.01 mmHg) as a colorless to pale yellow colored liquid. The compound was stored under N₂ atmosphere.

Preparation of Phosphines 1–3. The phosphines **1-3** were prepared in a similar procedure. A 3-neck, 500 mL, round-bottom flask, equipped with a mechanical stirrer, N₂ inlet, rubber septum, and an additional funnel, was charged with Et₂O (300 mL) and compound **D** (35.65 g, 150 mmol). The mixture was cooled to 0 °C and *n*-BuLi (64 mL, 160 mmol) was added slowly. The mixture was allowed to warm to room temperature and was stirred for one hour to form lithiated silylaniline intermediate. The mixture was again cooled to 0 °C, while stirring. Simultaneously, another 3-neck, 1000 mL, round-bottom flask, equipped with a mechanical stirrer, an N₂ inlet, a rubber septum, and an additional funnel, was charged with Et₂O (300 mL), and PCl₃ (20.60 g, 150 mmol). The mixture was cooled to -78 °C and the lithiated silylaniline (prepared above), which was at 0 °C, was added slowly from an additional funnel. After completion of the addition, the mixture was allowed to warm to 0 °C and was stirred for one hour, before CH₃MgBr (100 mL, 300 mmol) was added slowly. The reaction mixture was allowed to warm to room temperature and was stirred for four hours. Ether was removed under reduced pressure and hexane (300 mL) was added to precipitate the salt. The salt was removed by filtration and hexane was removed under reduced pressure. The product was distilled at 89-92 °C (0.01 mmHg) to yield phosphine **2**. The compound was stored under N₂ atmosphere. For the preparation of phosphine **1**, silylaniline reagent **A** was used instead of silylaniline reagent **D**.

Similarly, for the synthesis of phosphine **3**, silylaniline reagent **A** was used, and pre-synthesized $\text{LiOCH}_2\text{CF}_3$, was used instead of CH_3MgBr .

Preparation of Phosphine 4. A 3-neck, 1000 mL, round-bottom flask, equipped with a mechanical stirrer, N_2 inlet, rubber septum, and an additional funnel, was charged with Et_2O (500mL) and compound **A** (73.20 g, 300 mmol). The mixture was cooled to 0 °C and *n*-BuLi (124 mL, 310 mmol) was added slowly. The mixture was allowed to warm to room temperature and was stirred for one hour to form the lithiated silylaniline intermediate. The mixture was cooled to -78 °C and PCl_3 (20.64 g, 150 mmol) was added slowly. The reaction mixture was allowed to warm to room temperature and was stirred for three hours. The flask was again cooled to 0 °C, and CH_3MgBr (50 mL, 150 mmol) was added slowly. After the completion of the addition, the mixture was allowed to warm to room temperature and was stirred for three hours. Ether was removed under reduced pressure and hexane (300 mL) was added to precipitate the salt. The salt was removed by filtration and hexane was removed under reduced pressure. The product was distilled at 175-178 °C (0.01 mmHg) to yield phosphine **4**. The compound was stored under N_2 atmosphere.

Preparation of Phosphines 5 and 6. A 3-neck, 500 mL, round-bottom flask, equipped with a mechanical stirrer, N_2 inlet, rubber septum, and an additional funnel, was charged with Et_2O (250 mL) and compound **A** (27.7 g, 113.50 mmol). The mixture was cooled to 0 °C and *n*-BuLi (48 mL, 118 mmol) was added slowly. The mixture was allowed to warm to room temperature and was stirred for one hour to form the lithiated silylaniline intermediate. The mixture was cooled to -78 °C and Ph_2PCl (24.93 g, 113.50 mmol) was added slowly. The reaction mixture was allowed to warm to room temperature

and was stirred for four hours. Ether was removed under reduced pressure and hexane (300 mL) was added to precipitate the salt. The salt was removed by filtration and hexane was removed under reduced pressure. The product was distilled at 175-180 °C (0.01 mmHg) to yield phosphine **5**. The compound was stored under N₂ atmosphere.

The preparation of phosphine **6** was carried out by using silylaniline reagent **D** in place of silylaniline reagent **A**. The product was distilled at 178-185 °C (0.01 mmHg) and stored under N₂ atmosphere.

Preparation of Phosphines 7-12. The phosphines **7-12** were prepared in a manner based on the Wilburn procedure.^{15, 16} A 3-neck, 500 mL, round-bottom flask, equipped with a mechanical stirrer, N₂ inlet, rubber septum, and an additional funnel, was charged with Et₂O (200 mL) and compound **A** (24.40 g, 100 mmol). The mixture was cooled to 0 °C and *n*-BuLi (42 mL, 105 mmol) was added slowly. The mixture was allowed to warm to room temperature and was stirred for one hour to form lithiated silylaniline intermediate. The mixture was cooled to -78 °C and PhPCl₂ (17.90 g, 100 mmol) was added drop wise. After the completion of the addition, the mixture was allowed to warm to room temperature and was stirred for three hours. The mixture was cooled to 0 °C and CH₃MgBr (33.33 mL, 100 mmol) was added slowly. The reaction mixture was allowed to warm to room temperature and was stirred for three hours. Ether was removed under reduced pressure and hexane (200 mL) was added to precipitate the salt. The salt was removed by filtration and hexane was removed under reduced pressure. The product was distilled at 130-134 °C (0.01 mmHg) to yield phosphine **7**.

Compounds **8-12** were synthesized according to the procedure described above. For compound **8**, reagents **D** and CH_3MgBr were used, for compound **9** and **10**, silylaniline reagents **A** and **D** were used respectively and *n*-BuLi was added to substitute the remaining chlorine. Similarly, for the preparation of compounds **11** and **12**, silylaniline reagents **A** and **D** were used respectively and pre-synthesized $\text{LiOCH}_2\text{CF}_3$ was added to replace the remaining chlorine. Compounds **7-12** were stored under N_2 atmosphere.

Preparation of Compounds 13-17. The Staudinger reaction^{31a} of the phosphines was carried out in a similar manner as the literature procedure. A one-necked round-bottom flask, equipped with a magnetic stir bar, nitrogen inlet, and a reflux condenser was charged with compound **1** (14.1 g, 46.35 mmol) and Me_3SiN_3 (21.36 g, 185.40 mmol). The mixture was heated at 100-110 °C for 72 hours. Vacuum distillation of the crude mixture gave the *N*-silylphosphoranimine **13** at 130-135 °C (0.01 mmHg). Similar procedure was followed to synthesize compounds **14-17** from phosphines **3**, **7**, **9**, **11** respectively. Compounds **13 -17** were stored under N_2 atmosphere.

Preparation of Compounds 18-21. Compound **1** (10 g, 32.87 mmol) and CH_2Cl_2 (100 mL) were combined in a round bottom flask (250 mL), equipped with a magnetic stirring bar, an additional funnel, and an N_2 inlet. The mixture was cooled to 0 °C and CH_3I (4.66 g, 32.87 mmol) was added slowly. The mixture was warmed to room temperature and stirred for 4 hours. The flask containing mixture was again cooled to 0 °C and *n*-BuLi (13.6 mL, 34 mmol) was added dropwise. After the mixture was stirred overnight at room temperature, solvents were removed under reduced pressure and hexane (100 mL) was added to precipitate the salt. The salt was filtered and hexane was removed under reduced pressure. Distillation of the crude at 190-194 °C (0.15 mmHg) gave a

mixture of compounds **18** and **19**. Compound **7** was treated in a similar procedure to give a mixture of compounds **20** and **21**.

Preparation of Phosphoranimines 22-28. The phosphoranimines were prepared in a manner similar to the literature procedure.^{31, 32} A three-neck 1000 mL round-bottom flask, equipped with a mechanical stirrer, a rubber septum, an N₂ inlet, and an additional funnel, was charged with compound **1** (31.7 g, 104.2 mmol) and benzene (250 mL). The mixture was cooled to 0 °C and Br₂ (17.9 g, 112 mmol), dissolved in benzene (30 mL), was added slowly. The reaction mixture was stirred at room temperature for 90 minutes. Solvents and Me₃SiBr were removed under reduced pressure and then, CH₂Cl₂ (30 mL) and Et₂O (100 mL) were added to form solution **E**. A separate 3-neck, 500 mL round bottom flask, equipped with a mechanical stirrer, an N₂ inlet, rubber septum and an additional funnel, was charged with CF₃CH₂OH (12.5 g, 125 mmol) and Et₂O (200 mL). The mixture was cooled to 0 °C and *n*-BuLi (50 mL, 125 mmol) was added slowly. The mixture was allowed to warm to room temperature and was stirred for one hour to form a solution of LiOCH₂CF₃. The flask containing the solution **E** was cooled to 0 °C, to which the solution of LiOCH₂CF₃ was added slowly. After the addition, the reaction mixture was allowed to warm to room temperature and stirred for 4 hours. Solvents were removed under reduced pressure and hexane (500 mL) was added to precipitate the salt. The salt was removed by filtration and hexane was removed under reduced pressure and the product was distilled at 120-125 °C (0.1 mmHg) to yield compound **22** as a pale yellow liquid. Compounds **23-28** were prepared by the same procedure. The compounds were stored under N₂ atmosphere.

Metal-halogen Exchange Reaction of Compound 23. The reaction was carried out in a 3-neck 500 mL round-bottom flask, equipped with a mechanical stirrer, N₂ inlet, and an additional funnel. The flask was charged with Et₂O (200 mL) and compound **25** (13.7 g, 27.5 mmol). The reaction mixture was cooled to -78 °C and *t*-BuLi (35.30 mL, 60 mmol) was added dropwise. The reaction mixture was kept at -78 °C and stirred for one hour and then Me₃SiCl (3.86 g, 35.50 mmol) was added slowly. The mixture was allowed to warm to 0 °C and was stirred for one hour. The reaction was then stirred for 3 hours at room temperature. Ether was removed under reduced pressure and hexane (200 mL) was added to precipitate the salt. The salt was removed by filtration and hexane was removed under reduced pressure. The product was distilled at 90-100 °C (0.1 mmHg) to yield compound **29**. The compound **29** is stored under N₂ atmosphere.

Thermal Condensation of N-Silylphosphoranimines 14-17. The thermal condensation of *N*-silylphosphoranimines was carried out according to the literature procedure.⁴⁷ Compound **14** (4.47 g, 8.0 mmol) was vacuumed distilled into a thick-walled glass ampule (20 mL capacity) and was sealed at the constriction with a torch. The ampule was covered with glass wool and kept in steel pipe for safety and was heated in a thermo-regulated oven at 200 °C for two weeks. The ampule was opened and the volatile byproduct Me₃SiOCH₂CF₃ (1.17 g, 6.8 mmol) was collected in a cold trap and identified by ¹H NMR spectroscopy. The brown solid residue was dissolved in CH₂Cl₂ (≈ 10 mL) and then poured into hexane (≈ 200 mL) to precipitate the product. Drying under vacuum for 24 hours gave compound **30** (2.63 g, 85 % yield). Polymer **31** was also prepared in the same manner.

Table 1. NMR Spectroscopic Data for Compounds **C** and **D**

Compound	Signal	¹ H NMR	¹³ C NMR
		δ	δ
 <p style="text-align: center;">C</p>	NSi(CH ₃) ₃	0.00(s)	0.00(s)
	CSi(CH ₃) ₃	0.19(s)	2.99(s)
	NC ₆ H ₄	6.8-7.3(m)	
			
	<i>C</i> ₁		149.40(s)
	<i>C</i> _{2,6}		130.39(s)
	<i>C</i> _{3,5}		134.38(s)
	<i>C</i> ₄		116.50(s)

Table 1. NMR Spectroscopic Data for Compounds **C** and **D** (continued)

Compound	Signal	¹ H NMR	¹³ C NMR
		δ	δ
 <p style="text-align: center;">D</p>	$\text{NSi}(\text{CH}_3)_3$	0.01(s)	0.00(s)
	$\text{CSi}(\text{CH}_3)_3$	0.06(s)	0.88(s)
	NH	3.28(s)	
	NC_6H_4	6.4-7.1(m)	
	C_1		148.98(s)
	$C_{2,6}$		135.38(s)
	$C_{3,5}$		116.44(s)
	C_4		127.78(s)

Table 2. NMR Spectroscopic Data for Compounds **1-12**

Compound	Signal	¹ H NMR		¹³ C NMR		³¹ P NMR	
		δ	J _{PH}	δ	J _{PC}	δ	
 <p style="text-align: center;">1</p>	Si(CH ₃) ₃	0.00(s)		0.06(s)			
	PCH ₃	0.82(d)	6.0	16.28(d)	17.9	16.80	
	NC ₆ H ₄	6.57-7.32(m)					
		C ₁			140.22(d)	10.1	
		C _{2,6}			130.64(s)		
		C _{3,5}			132.01(s)		
	C ₄			116.43(s)			

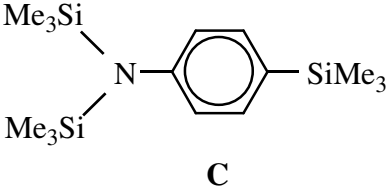
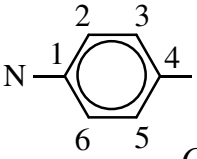
Table 2. NMR Spectroscopic Data for Compounds **1-12** (continued)

Compound	Signal	¹ H NMR		¹³ C NMR		³¹ P NMR
		δ	J _{PH}	δ	J _{PC}	δ
 <p style="text-align: center;">2</p>	NSi(CH ₃) ₃	0.05(s)		0.15(s)		
	CSi(CH ₃) ₃	0.21(s)		1.05(s)		
	PCH ₃	0.87(d)	5.7	20.07(d)	12.4	16.45
	NC ₆ H ₄	6.7-7.4(m)				
		C ₁			149.16(s)	
	C _{2,6}			135.50(s)		
	C _{3,5}			127.92(s)		
	C ₄			116.58(s)		

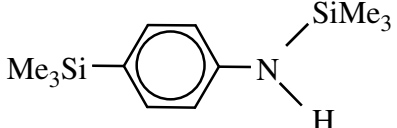
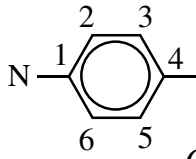
Table 2. NMR Spectroscopic Data for Compounds **1-12** (continued)

Compound	Signal	¹ H NMR		¹³ C NMR		³¹ P NMR
		δ	J _{PH}	δ	J _{PC}	δ
 3	Si(CH ₃) ₃	0.00(d)	1.5	0.05(d)		8.1
	POCH ₂ CF ₃	3.7-3.9(m)		61.11(dq)	18.4	147.33 36 ^a
	OCH ₂ CF ₃			122.74(dq)	8.2	278.4 ^a
	NC ₆ H ₄	6.7-7.2(m)				
	C ₁			137.54(s)		
	C _{2,6}			131.38(d)		
	C _{3,5}			131.05(s)		
	C ₄			119.12(s)		

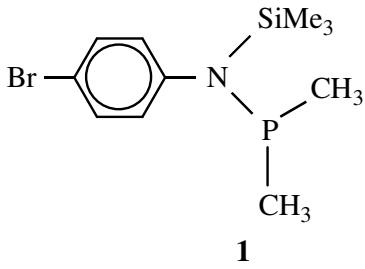
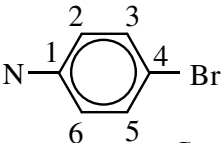
^a J_{FC} value

Table 2. NMR Spectroscopic Data for Compounds **1-12** (continued)

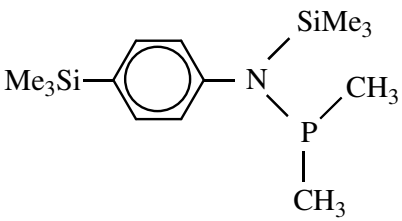
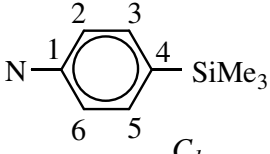
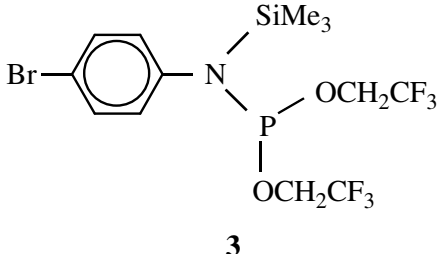
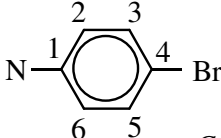
Compound	¹ H NMR		¹³ C NMR		³¹ P NMR	
	Signal	δ	J _{PH}	δ	J _{PC}	δ
<p style="text-align: center;">4</p>	Si(CH ₃) ₃	0.00(s)		0.05(d)		8.1
	PCH ₃	0.86(d)	11.7	17.00(d)	22.5	67.62
	NC ₆ H ₄	6.3-7.2(m)				
		C ₁			141.78(d)	7.5
	C _{2,6}			131.66(s)		
	C _{3,5}			130.09(s)		
	C ₄			116.91(s)		

Table 2. NMR Spectroscopic Data for Compounds **1-12** (continued)

Compound	Signal	¹ H NMR		¹³ C NMR		³¹ P NMR	
		δ	J _{PH}	δ	J _{PC}	δ	
 <p style="text-align: center;">5</p>	Si(CH ₃) ₃	0.01(s)		1.63(s)			
	PNC ₆ H ₄	6.1-6.8(m)				51.54	
		C ₁			144.47(s)		
		C _{2,6}			133.11(s)		
		C _{3,5}			128.93(s)		
		C ₄			110.00(s)		
	PC ₆ H ₅	7.0-7.1(m)					
		C ₇			133.25(d)	20.7	
		C _{8,12}			128.17(d)	6.0	
		C _{9,11}			131.30(s)		
	C ₁₀			128.93(s)			

Table 2. NMR Spectroscopic Data for Compounds **1-12** (continued)

Compound	Signal	¹ H NMR		¹³ C NMR		³¹ P NMR	
		δ	J _{PH}	δ	J _{PC}	δ	
 <p style="text-align: center;">6</p>	NSi(CH ₃) ₃	0.00(s)		0.00(s)			
	CSi(CH ₃) ₃	0.11(s)		2.54(d)	8.1		
	PNC ₆ H ₄	6.4-6.9(m)				52.28	
		C ₁			136.82(s)		
		C _{2,6}			133.91(s)		
		C _{3,5}			129.45(s)		
		C ₄			128.76(d)	6.0	
	PC ₆ H ₅	7.1-7.2(m)					
		C ₇			134.05(d)	20.6	
		C _{8,12}			128.98(d)	5.8	
	C _{9,11}			132.12(s)			
	C ₁₀			130.29(s)			

Table 2. NMR Spectroscopic Data for Compounds **1-12** (continued)

Compound	Signal	¹ H NMR		¹³ C NMR		³¹ P NMR	
		δ	J _{PH}	δ	J _{PC}	δ	
 <p style="text-align: center;">7</p>	Si(CH ₃) ₃	0.02(s)		1.30(s)			
	PCH ₃	1.10(d)	7.5	12.31(d)	17.3	27.51	
	NC ₆ H ₄	6.1-7.0(m)					
		C ₁			141.03(s)		
		C _{2,6}			131.18(s)		
		C _{3,5}			132.15(s)		
		C ₄			117.73(s)		
	PC ₆ H ₅	7.0-7.1(m)					
		C ₇			131.36(d)	19.3	
		C _{8,12}			128.06(d)	5.1	
	C _{9,11}			128.65(s)			
	C ₁₀			118.12(s)			

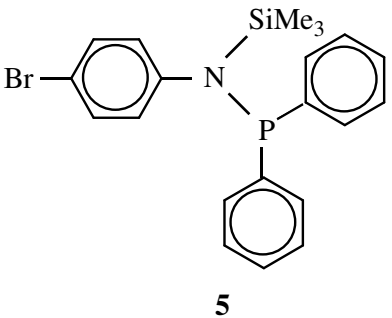
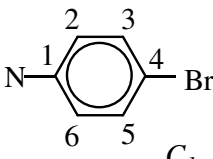
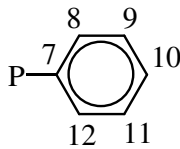
Table 2. NMR Spectroscopic Data for Compounds 1-12 (continued)

Compound	Signal	¹ H NMR		¹³ C NMR		³¹ P NMR	
		δ	J _{PH}	δ	J _{PC}	δ	
 <p style="text-align: center;">8</p>	NSi(CH ₃) ₃	0.01(s)		0.00(s)			
	CSi(CH ₃) ₃	0.01(s)		2.36(d)	8.4		
	PCH ₃	1.09(d)	7.2	13.49(d)	16.4	28.39	
	NC ₆ H ₄	6.3-7.0(m)					
	C ₁			144.73(s)			
	C _{2,6}			143.04(s)			
	C _{3,5}			134.05(s)			
	C ₄			130.58(s)			
	PC ₆ H ₅	7.0-7.1(m)					
	C ₇			132.13(d)	19.0		
	C _{8,12}			128.82(d)	5.2		
	C _{9,11}			129.18(s)			
	C ₁₀			136.80(s)			

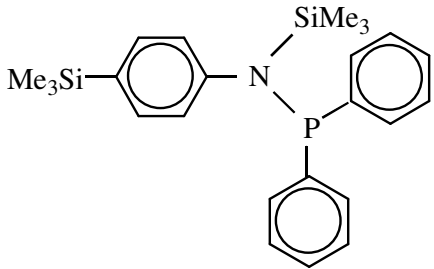
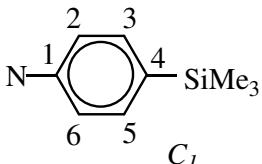
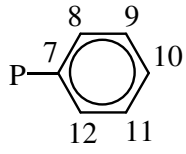
Table 2. NMR Spectroscopic Data for Compounds **1-12** (compound)

Compound	Signal	¹ H NMR		¹³ C NMR		³¹ P NMR		
		δ	J _{PH}	δ	J _{PC}	δ		
 <p style="text-align: center;">9</p>	Si(CH ₃) ₃	0.01(s)		0.05(s)				
	CH ₂ CH ₂ CH ₃	0.77(t)	6.2 ^a	12.68(s)				
	CH ₂ CH ₂ CH ₃	1.3-1.4(m)		23.97(d)	14.1			
	PCH ₂ CH ₂	1.3-1.4(m)		24.18(d)	13.8			
	PCH ₂	1.5-1.6(m)		25.78(d)	19.6	35.49		
	NC ₆ H ₄	6.1-7.0(m)						
		C ₁			141.08(d)	8.9		
		C _{2,6}			129.78(s)			
		C _{3,5}			130.62(s)			
		C ₄			116.71(s)			
PC ₆ H ₅	7.07-7.14(m)							
	C ₇			138.52(d)	19.3			
	C _{8,12}			130.92(d)	20.4			
	C _{9,11}			126.67(d)	5.8			
	C ₁₀			127.57(s)				

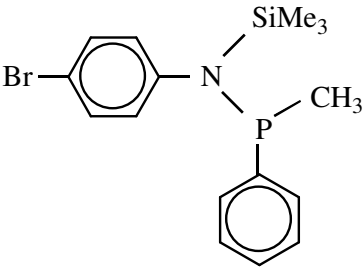
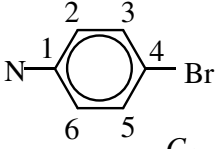
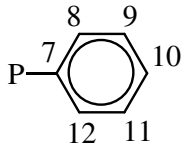
^a J_{HH} value

Table 2. NMR Spectroscopic Data for Compounds **1-12** (continued)

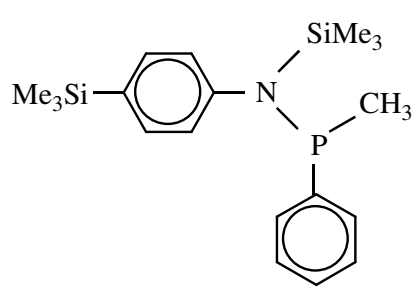
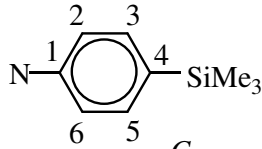
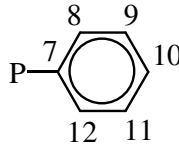
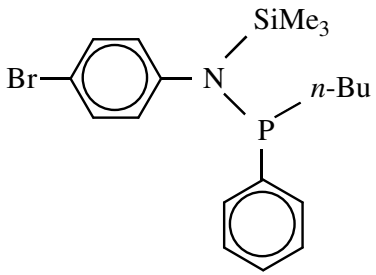
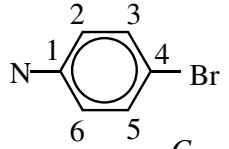
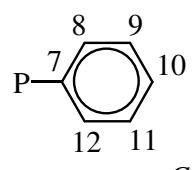
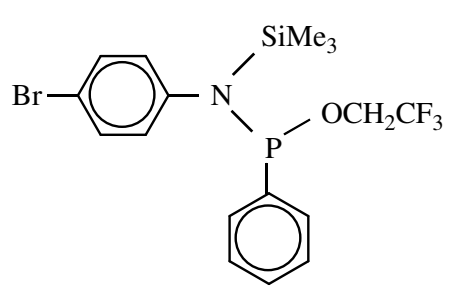
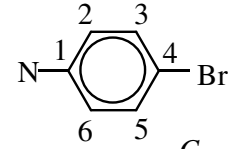
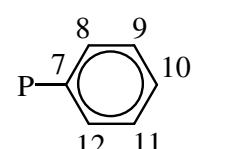
Compound	Signal	¹ H NMR		¹³ C NMR		³¹ P NMR	
		δ	J _{PH}	δ	J _{PC}	δ	
 <p style="text-align: center;">11</p>	Si(CH ₃) ₃	0.01(s)		0.05(s)			
	POCH ₂ CF ₃	3.9-4.1(m)		64.17(dq)	25.9	125.78	
	OCH ₂ CF ₃			122.79(dq)	10.0	268.6 ^a	
	NC ₆ H ₄	6.2-6.9(m)					
		C ₁			140.02(d)	5.5	
		C _{2,6}			129.87(s)		
		C _{3,5}			130.18(s)		
		C ₄			117.30(s)		
	PC ₆ H ₅	6.9-7.0(m)					
		C ₇			138.12(d)	9.2	
	C _{8,12}			128.58(d)	22.7		
	C _{9,11}			126.60(s)			
	C ₁₀			128.12(s)			

^a J_{FC} value

Table 2. NMR Spectroscopic Data for Compounds **1-12** (continued)

Compound	Signal	¹ H NMR		¹³ C NMR		³¹ P NMR
		δ	J _{PH}	δ	J _{PC}	δ
<p style="text-align: center;">12</p>	NSi(CH ₃) ₃	0.00(s)		0.00(s)		
	CSi(CH ₃) ₃	0.05(s)		2.44(d)	8.1	
	POCH ₂ CF ₃	4.0-4.2(m)		66.31(dq)	25.6	127.10
					58.1 ^a	
	OCH ₂ CF ₃			123.66(dq)	<i>b</i>	268.3 ^a
	NC ₆ H ₄	6.4-7.0(m)				
		C ₁			143.78(d)	4.0
		C _{2,6}			137.40(s)	
		C _{3,5}			130.13(s)	
		C ₄			128.58(s)	
		PC ₆ H ₅	7.0-7.1(m)			
		C ₇			140.91(d)	8.7
C _{8,12}				130.98(d)	23.1	
C _{9,11}				134.11(s)		
C ₁₀				130.19(s)		

^a J_{FC} value^b J_{PC} value not clear

Table 3. NMR Spectroscopic Data for Compounds **13-17** (continued)

Compound	Signal	¹ H NMR		¹³ C NMR		³¹ P NMR	
		δ	J _{PH}	δ	J _{PC}	δ	
<p style="text-align: center;">14</p>	Si(CH ₃) ₃	0.00(s)		-0.01(s)			
	P=NSi(CH ₃) ₃	0.25(s)		1.99(s)			
	POCH ₂ CF ₃	4.1-4.3(m)		61.45(dq)	4.4	-6.35	
					37.1 ^a		
	OCH ₂ CF ₃			122.14(dq)	11.2		
					265.9 ^a		
	NC ₆ H ₄	7.0-7.5(m)					
	C ₁			139.39(s)			
	C _{2,6}			131.27(d)	15.5		
	C _{3,5}			119.09(s)			
	C ₄			114.71(s)			

^a J_{FC} value

Table 3. NMR Spectroscopic Data for Compounds **13-17** (continued)

Compound	Signal	¹ H NMR		¹³ C NMR		³¹ P NMR	
		δ	J _{PH}	δ	J _{PC}	δ	
<p style="text-align: center;">15</p>	NSi(CH ₃) ₃	0.00(s)		0.00(s)			
	=NSi(CH ₃) ₃	0.15(s)		1.21(d)		3.5	
	PCH ₃	1.50(d)	12.9	15.78(d)		81.8	9.80
	NC ₆ H ₄	6.6-7.3(m)					
	C ₁			139.72(s)			
	C _{2,6}			127.90(d)		3.5	
	C _{3,5}			128.01(s)			
	C ₄			116.83(s)			
	PC ₆ H ₅	7.3-7.6(m)					
	C ₇			130.30(s)			
	C _{8,12}			125.32(d)		12.1	
	C _{9,11}			129.31(s)			
	C ₁₀			127.87(s)			

Table 3. NMR Spectroscopic Data for Compounds **13-17** (continued)

Compound	Signal	¹ H NMR		¹³ C NMR		³¹ P NMR	
		δ	J _{PH}	δ	J _{PC}	δ	
 <p style="text-align: center;">16</p>	NSi(CH ₃) ₃	0.01(s)		0.00(s)			
	P=NSi(CH ₃) ₃	0.13(s)		1.15(d)	2.9		
	CH ₂ CH ₂ CH ₃	0.90(t)	7.2	11.12(s)			
	CH ₂ CH ₂ CH ₃	1.3-1.4(m)		21.06(d)	2.8		
	PCH ₂ CH ₂	1.4-1.7(m)		21.44(d)	16.7		
	PCH ₂	1.7-1.8(m)		26.15(d)	83.4	13.81	
	NC ₆ H ₄	6.7-7.3(m)					
		C ₁			139.47(s)		
		C _{2,6}			128.02(d)	9.5	
		C _{3,5}			130.08(s)		
C ₄				116.52(s)			
PC ₆ H ₅	7.2-7.8(m)						
	C ₇			128.94(d)	11.5		
	C _{8,12}			125.06(d)	11.7		
	C _{9,11}			128.50(s)			
	C ₁₀			127.67(s)			

Table 3. NMR Spectroscopic Data for Compounds **13-17** (continued)

Compound	Signal	¹ H NMR		¹³ C NMR	³¹ P NMR	
		δ	J _{PH}	δ	J _{PC}	δ
<p style="text-align: center;">17</p>	NSi(CH ₃) ₃	0.00(s)		-0.01(s)		
	P=NSi(CH ₃) ₃	0.24(s)		1.09(d)		3.2
	POCH ₂ CF ₃	4.2-4.3(m)		59.90(dq)	32.8	7.81
					81.2 ^a	
	OCH ₂ CF ₃			127.40(dq)	14.4	
					226.6 ^a	
	NC ₆ H ₄	6.6-7.2(m)				
		<i>C</i> ₁			138.49(s)	
		<i>C</i> _{2,6}			130.06(s)	
		<i>C</i> _{3,5}			131.74(s)	
	<i>C</i> ₄			117.24(s)		
PC ₆ H ₅	7.3-7.5(m)					
	<i>C</i> ₇			129.13(d)	10.0	
	<i>C</i> _{8,12}			128.91(s)		
	<i>C</i> _{9,11}			130.11(s)		
	<i>C</i> ₁₀			129.45(s)		

^a J_{FC} value

Table 4. NMR Spectroscopic Data for Compounds **18-21**

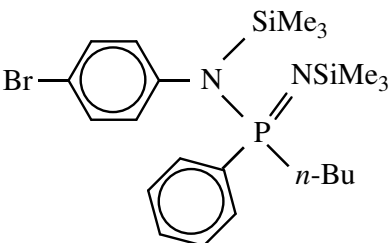
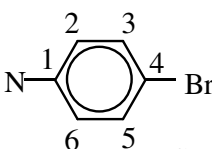
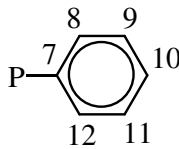
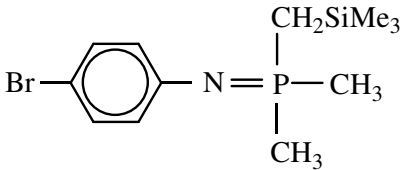
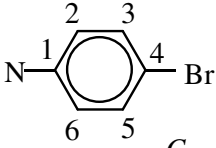
Compound	Signal	¹ H NMR		¹³ C NMR		³¹ P NMR	
		δ	J _{PH}	δ	J _{PC}	δ	
 <p style="text-align: center;">18</p>	Si(CH ₃) ₃	0.01(s)		0.11(s)			
	PCH ₂	1.22(d)	4.0	18.62(d)	57.3		
	PCH ₃	1.52(d)	3.3	20.85(d)	53.6	13.56	
	NC ₆ H ₄	6.3-7.1(m)					
		C ₁			<i>a</i>		
		C _{2,6}			123.63(d)	18.2	
		C _{3,5}			131.33(d)	12.4	
	C ₄			<i>a</i>			

^a not observed

Table 4. NMR Spectroscopic Data for Compounds **18-21** (continued)

Compound	Signal	¹ H NMR		¹³ C NMR		³¹ P NMR	
		δ	J _{PH}	δ	J _{PC}	δ	
 <p style="text-align: center;">19</p>	Si(CH ₃) ₃	0.13(s)		0.15(s)			
	PCH ₂	1.55(d)	3.6	16.49(d)	70.5		
	PCH ₃	1.92(d)	3.2	17.94(d)	75.4	11.78	
	NC ₆ H ₄	6.5-7.2(m)					
		C ₁			131.33(d)	13.0	
	C _{2,6}			151.36(s)			
	C _{3,5}			128.95(d)	18.1		
	C ₄			108.91(s)			
	PC ₆ H ₅	7.5-7.8(m)					
	C ₇			130.33(d)	57.0		
	C _{8,12}			123.99(d)	20.1		
	C _{9,11}			134.77(s)			
	C ₁₀			131.70(s)			

Table 4. NMR Spectroscopic Data for Compounds **18-21** (continued)

Compound	Signal	¹ H NMR		¹³ C NMR		³¹ P NMR	
		δ	J _{PH}	δ	J _{PC}	δ	
 <p style="text-align: center;">20</p>	Si(CH ₃) ₃	0.00(s)		0.01(s)			
	PCH ₃	1.22(d)	4.0	15.70(d)	67.4		
	PCH ₃	1.50(d)	3.1	17.35(d)	66.2	10.96	
	NC ₆ H ₄	6.3-7.1(m)					
		C ₁			<i>a</i>		
	C _{2,6}			123.43(d)	19.0		
	C _{3,5}			131.17(d)	12.4		
	C ₄			<i>a</i>			

^a not observed

Table 4. NMR Spectroscopic Data for Compounds **18-21** (continued)

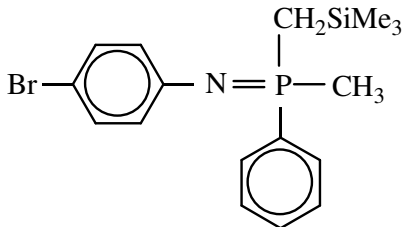
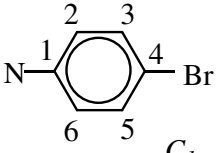
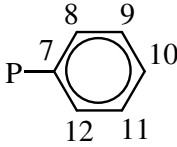
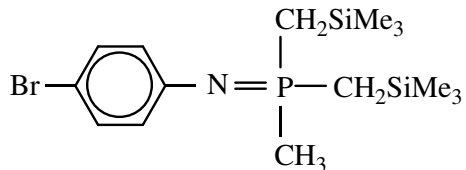
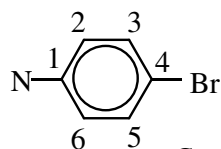
Compound	Signal	¹ H NMR		¹³ C NMR		³¹ P NMR	
		δ	J _{PH}	δ	J _{PC}	δ	
 <p style="text-align: center;">21</p>	Si(CH ₃) ₃	0.00(s)		0.20(s)			
	PCH ₂	1.55(d)	3.6	15.34(d)	73.9		
	PCH ₃	1.88(d)	3.2	16.49(d)	70.5	9.59	
	NC ₆ H ₄	6.5-7.2(m)					
		C ₁			131.30(d)	11.5	
	C _{2,6}			151.36(s)			
	C _{3,5}			128.76(d)	18.1		
	C ₄			108.16(s)			
	PC ₆ H ₅	7.5-7.8(m)					
	C ₇			130.34(d)	56.1		
	C _{8,12}			123.90(d)	19.8		
	C _{9,11}			133.71(s)			
	C ₁₀			131.66(s)			

Table 5. NMR Spectroscopic Data for Compounds **22-29**

Compound	Signal	¹ H NMR		¹³ C NMR	³¹ P NMR		
		δ	J _{PH}	δ	J _{PC}	δ	
 22	<i>PCH</i> ₃	1.71(d)	13.5	14.06(d)	96.2	41.94	
	<i>OCH</i> ₂ CF ₃	4.2-4.3(m)		60.30(dq)	4.9		
						32.5 ^a	
	<i>OCH</i> ₂ CF ₃			120.98(dq)	5.7		
						277.8 ^a	
	<i>NC</i> ₆ <i>H</i> ₄	6.6-7.3(m)					
		<i>C</i> ₁		148.34(d)	4.9		
		<i>C</i> _{2,6}		124.82(d)	17.5		
		<i>C</i> _{3,5}		132.25(s)			
		<i>C</i> ₄		111.99(s)			

^a J_{FC} value

Table 5. NMR Spectroscopic Data for Compounds **22-29** (continued)

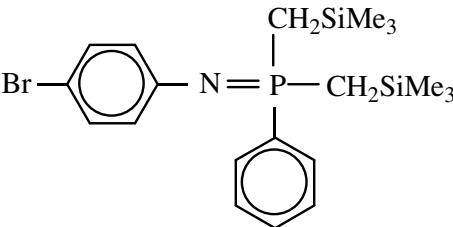
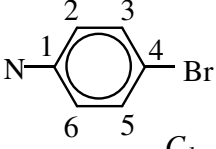
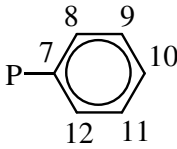
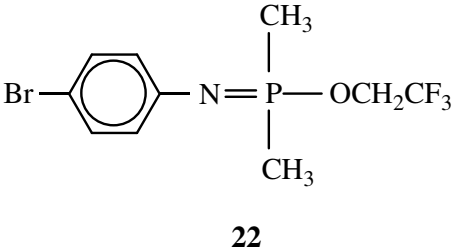
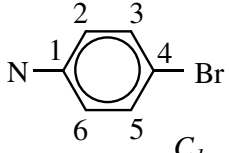
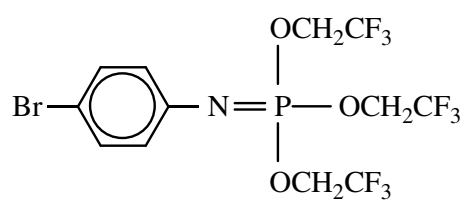
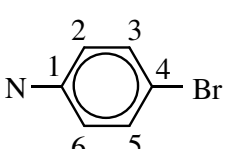
Compound	Signal	¹ H NMR		¹³ C NMR		³¹ P NMR
		δ	J _{PH}	δ	J _{PC}	δ
 <p style="text-align: center;">23</p>	<i>POCH₂CF₃</i>	4.4-4.2(m)		64.61(dq)	7.2	-14.93
					38.3 ^a	
	<i>OCH₂CF₃</i>			122.40(dq)	9.8	
					267.8 ^a	
	<i>NC₆H₄</i>	6.7-7.3(m)				
						
	<i>C₁</i>			142.83(d)	8.3	
	<i>C_{2,6}</i>			125.16(d)	15.5	
	<i>C_{3,5}</i>			132.29(s)		
	<i>C₄</i>			113.73(s)		

^a J_{FC} value

Table 5. NMR Spectroscopic Data for Compounds **22-29** (continued)

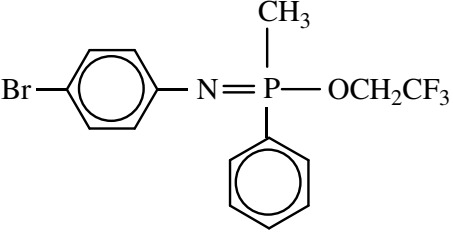
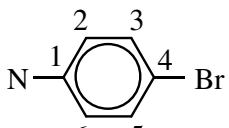
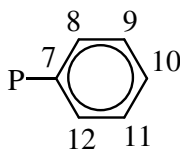
Compound	Signal	¹ H NMR		¹³ C NMR		³¹ P NMR	
		δ	J _{PH}	δ	J _{PC}	δ	
 <p style="text-align: center;">24</p>	<i>PCH</i> ₃	1.06(d)	13.8	14.21(d)	96.4	29.58	
	<i>OCH</i> ₂ <i>CF</i> ₃	3.2-3.3(m)		60.50(dq)	4.6		
	<i>OCH</i> ₂ <i>CF</i> ₃	3.5-3.6(m)		<i>b</i>		37.2 ^a	
	<i>NC</i> ₆ <i>H</i> ₄	5.9-6.5(m)					
		<i>C</i> ₁			148.18(d)	4.0	
	<i>C</i> _{2,6}			131.95(d)	9.8		
	<i>C</i> _{3,5}			133.05(s)			
	<i>C</i> ₄			111.95(s)			
	<i>PC</i> ₆ <i>H</i> ₅	6.7-7.1(m)					
	<i>C</i> ₇			129.23(d)	12.9		
	<i>C</i> _{8,12}			125.17(d)	17.9		
	<i>C</i> _{9,11}			132.11(s)			
	<i>C</i> ₁₀			127.68(s)			

^a J_{FC} value^b Not observed

Table 5. NMR Spectroscopic Data for Compounds **22-29** (continued)

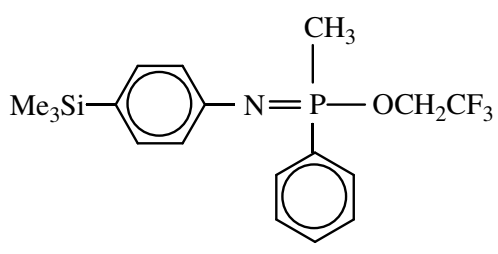
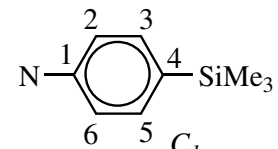
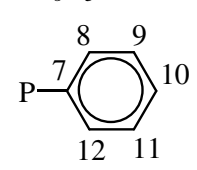
Compound	Signal	¹ H NMR		¹³ C NMR		³¹ P NMR	
		δ	J _{PH}	δ	J _{PC}	δ	
 <p style="text-align: center;">25</p>	CSi(CH ₃) ₃	0.04(s)		0.00(s)			
	PCH ₃	1.70(d)	14.1	15.10(d)	95.6	30.50	
	OCH ₂ CF ₃	3.8-4.0(m)		61.28(dq)	4.3		
					34.8 ^a		
	OCH ₂ CF ₃	4.1-4.3(m)		129.81(dq)	6.3		
					<i>b</i>		
	NC ₆ H ₄	6.5-7.2(m)					
		C ₁			141.68(s)		
		C _{2,6}			125.81(d)	8.9	
		C _{3,5}			135.30(s)		
	C ₄			120.89(d)	6.6		
PC ₆ H ₅	7.3-7.8(m)						
	C ₇			132.63(d)	10.0		
	C _{8,12}			123.67(d)	18.1		
	C _{9,11}			132.77(s)			
	C ₁₀			127.68(s)			

^a J_{FC} value^b not observed

Table 5. NMR Spectroscopic Data for Compounds **22-29** (continued)

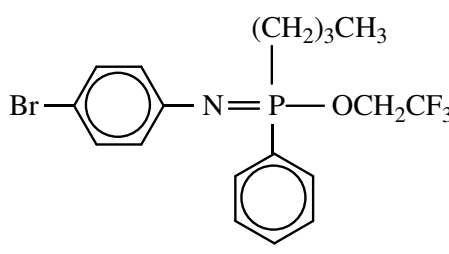
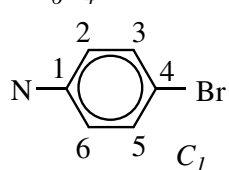
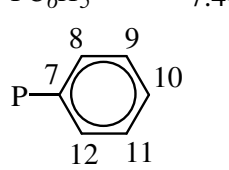
Compound	Signal	¹ H NMR		¹³ C NMR		³¹ P NMR		
		δ	J _{PH}	δ	J _{PC}	δ		
 <p style="text-align: center;">26</p>	CH ₂ CH ₃	0.71(t)	7.2	13.65(s)				
	CH ₂ CH ₂ CH ₂	1.2-1.3(m)		23.79(d)		17.3		
	CH ₂ CH ₂ CH ₂	1.9-2.1(m)		24.31(d)		2.9		
	PCH ₂	2.1-2.2(m)		27.58(d)	93.3	34.33		
	OCH ₂ CF ₃	3.9-4.1(m)		60.64(dq)		4.9		
		4.2-4.3(m)				37.4 ^a		
	OCH ₂ CF ₃			120.98(dq)	10.0			
						273.3 ^a		
	NC ₆ H ₄	6.6-7.1(m)						
		C ₁			148.35(d)		3.8	
		C _{2,6}			129.21(d)		12.7	
		C _{3,5}			132.97(s)			
		C ₄			111.79(s)			
		PC ₆ H ₅	7.4-7.8(m)					
		C ₇			132.48(d)		9.3	
C _{8,12}				125.22(d)		17.8		
C _{9,11}				132.07(s)				
C ₁₀				126.52(s)				

^a J_{FC} value

Table 5. NMR Spectroscopic Data for Compounds **22-29** (continued)

Compound	Signal	¹ H NMR		¹³ C NMR	³¹ P NMR		
		δ	J _{PH}	δ	J _{PC}	δ	
<p style="text-align: center;">27</p>	<i>POCH₂CF₃</i>	4.2-4.4(m)		62.60(dq)	5.2	9.17	
					37.7 ^a		
	<i>OCH₂CF₃</i>			124.74(dq)	10.1		
					277.6 ^a		
	<i>NC₆H₄</i>	6.7-7.2(m)					
		<i>C₁</i>			145.17(d)	4.1	
		<i>C_{2,6}</i>			125.20(d)	15.8	
		<i>C_{3,5}</i>			133.82(s)		
		<i>C₄</i>			112.90(s)		
<i>PC₆H₅</i>		7.4-7.8(m)					
	<i>C₇</i>			129.29(d)	15.8		
	<i>C_{8,12}</i>			132.35(s)			
	<i>C_{9,11}</i>			132.29(s)			
	<i>C₁₀</i>			124.16(s)			

^a J_{FC} value

Table 5. NMR Spectroscopic Data for Compounds **22-29** (continued)

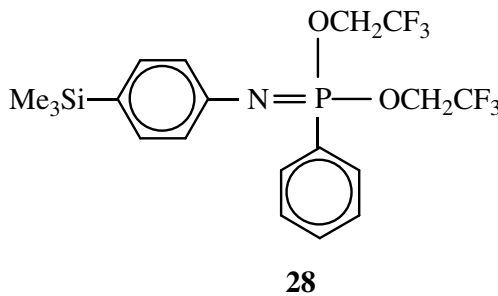
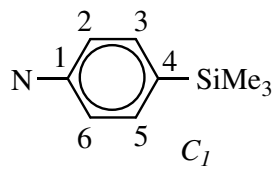
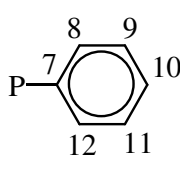
Compound	Signal	¹ H NMR		¹³ C NMR		³¹ P NMR		
		δ	J _{PH}	δ	J _{PC}	δ		
 <p style="text-align: center;">28</p>	NSi(CH ₃) ₃	0.03(d)	4.1	1.60(d)		8.3		
	POCH ₂ CF ₃	4.0-4.3(m)		62.55(dq)	5.1	8.05		
							36.6 ^a	
	OCH ₂ CF ₃			123.10(dq)	16.1			
							270.5 ^a	
	NC ₆ H ₄	6.4-7.0(m)						
		C ₁			140.06(d)	8.6		
		C _{2,6}			133.59(d)	2.9		
		C _{3,5}			136.55(s)			
		C ₄			127.73(d)	6.5		
PC ₆ H ₅		7.1-7.7(m)						
	C ₇			130.14(d)	23.0			
	C _{8,12}			134.73(s)				
	C _{9,11}			133.26(s)				
	C ₁₀			129.32(s)				

^a J_{FC}value

Table 5. NMR Spectroscopic Data for Compounds 22-29 (continued)

Compound	Signal	¹ H NMR		¹³ C NMR		³¹ P NMR		
		δ	J _{PH}	δ	J _{PC}	δ		
 29	NSi(CH ₃) ₃	0.07(s)		0.00(s)				
	POCH ₂ CF ₃	4.3-4.4(m)		64.93(dq)	7.2	-14.50		
						38.2 ^a		
	OCH ₂ CF ₃			122.36(dq)	9.8		263.5 ^a	
	NC ₆ H ₄	6.6-7.2(m)						
		C ₁			132.61(s)			
		C _{2,6}			125.48(d)	15.5		
		C _{3,5}			129.81(s)			
	C ₄			114.07(s)				
	^a J _{FC} value							

Table 6. NMR Spectroscopic Data for Compounds **30** and **31**

Compound	Signal	¹ H NMR		¹³ C NMR		³¹ P NMR	
		δ	J _{PH}	δ	J _{PC}	δ	
 <p>30</p>	NSi(CH ₃) ₃	0.26(s)					
	POCH ₂ CF ₃	4.1-4.7(m) ^a				-9.90 ^a	
	OCH ₂ CF ₃						
	NC ₆ H ₄	6.8-7.5(m) ^a					
							C ₁
							C _{2, 6}
						C _{3, 5}	
						C ₄	

^a broad resonance¹³C not obtained

Table 6. NMR Spectroscopic Data for Compounds **30** and **31**

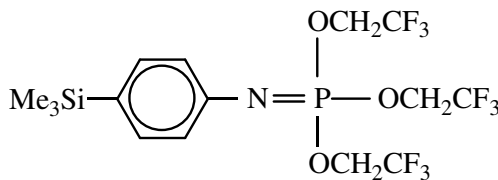
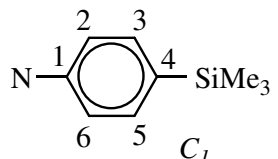
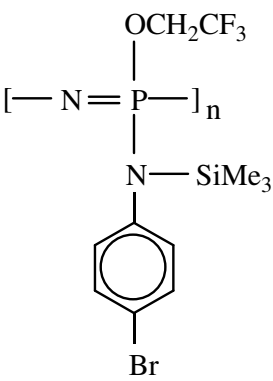
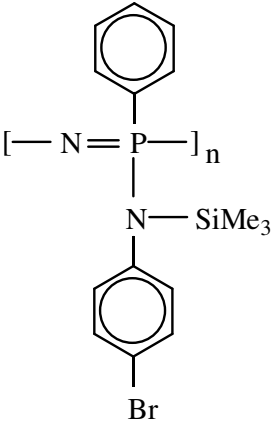
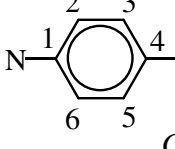
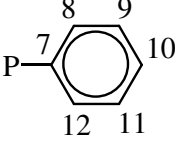
Compound	Signal	¹ H NMR		¹³ C NMR		³¹ P NMR
		δ	J _{PH}	δ	J _{PC}	δ
 <p>31</p>	NSi(CH ₃) ₃	0.36(s)		1.85(s)		
	PNC ₆ H ₄	6.1-8.4(m) ^a				-1.12-22.87 ^a
	 C ₁			145.49(s)		
	C _{2,6}			133.23(d)	13.8	
	C _{3,5}			132.14(s)		
	C ₄			116.76(s)		
	PC ₆ H ₅	6.1-8.4(m) ^a				
	 C ₇			131.23(d)	7.5	
	C _{8,12}			127.98(d)	15.2	
	C _{9,11}			132.02(s)		
C ₁₀			119.52(s)			

^a broad resonance

Table 7. Physical and Analytical Data for Compounds **1-17** and **22-28**

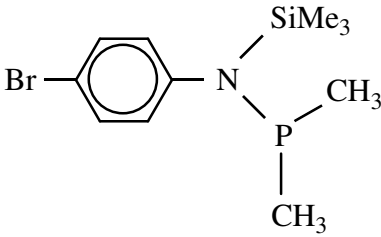
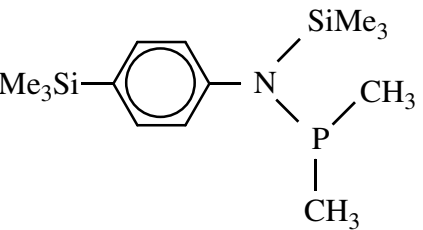
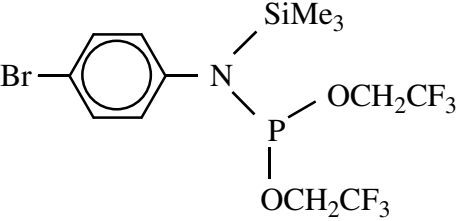
Compound	% Yield	bp, °C (mmHg)	% C (calc)	% H (calc)	% N (calc)
 1	66	90-94 °C (0.01)	43.77 (43.43)	6.73 (6.29)	4.60 (4.60)
 2	55	89-92 °C (0.01)	<i>a</i>		
 3	65	86-90 °C (0.01)	33.38 (33.06)	3.95 (3.63)	3.03 (2.97)

^a Not obtained due to presence of starting aniline reagent **D** as impurity

Table 7. Physical and Analytical Data for Compounds **1-17** and **22-28** (continued)

Compound	% Yield	bp, °C (mmHg)	% C (calc)	% H (calc)	% N (calc)
 4	65	175-178 °C (0.01)	42.94 (42.86)	5.79 (5.49)	5.28 (5.26)
 5	88	175-180 °C (0.01)	57.16 (58.88)	5.35 (5.41)	3.21 (3.27)
 6	70	178-185 °C (0.01)	67.51 (68.36)	8.32 (7.65)	3.32 (3.32)

Table 7. Physical and Analytical Data for Compounds **1-17** and **22-28** (continued)

Compound	% Yield	bp, °C (mmHg)	% C (calc)	% H (calc)	% N (calc)
 <p>7</p>	64	130-134 °C (0.01)	52.45 (52.46)	6.13 (5.78)	3.84 (3.82)
 <p>8</p>	60	140-144 °C (0.01)	62.02 (63.46)	8.83 (8.41)	3.83 (3.90)
 <p>9</p>	62	145-150 °C (0.01)	56.01 (55.88)	7.22 (6.66)	3.43 (3.43)

Table 7. Physical and Analytical Data for Compounds **1-17** and **22-28** (continued)

Compound	% Yield	bp, °C (mmHg)	% C (calc)	% H (calc)	% N (calc)
 10	66	141-147 °C (0.01)	65.30 (65.78)	9.85 (9.03)	3.42 (3.49)
 11	76	135-140 °C (0.01)	45.54 (45.34)	4.84 (4.48)	3.14 (3.11)
 12	65	120-127 °C (0.01)	53.94 (54.15)	6.99 (6.59)	3.16 (3.16)

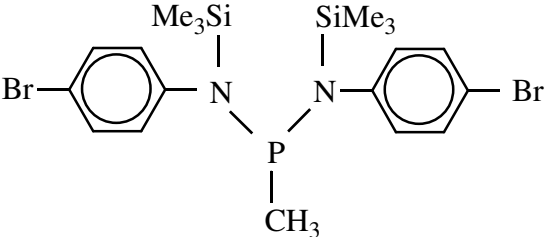
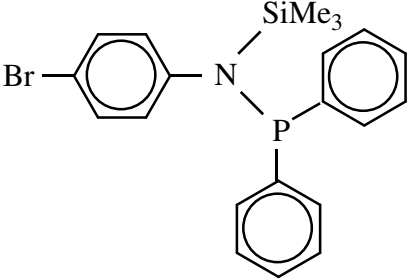
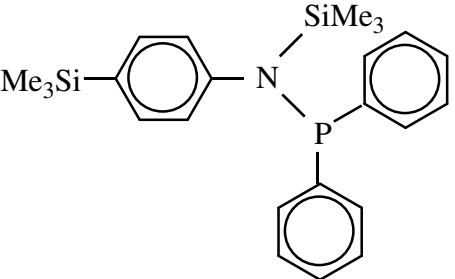
Table 7. Physical and Analytical Data for Compounds **1-17** and **22-28** (continued)

Compound	% Yield	bp, °C (mmHg)	% C (calc)	% H (calc)	% N (calc)
 13	75	130-135 °C (0.01)	43.23 (42.96)	7.56 (7.21)	7.22 (7.16)
 14	65	96-100 °C (0.01)	34.47 (34.35)	5.02 (4.68)	5.00 (5.01)
 15	65	163-166 °C (0.4)	49.93 (50.32)	7.37 (6.67)	6.28 (6.18)

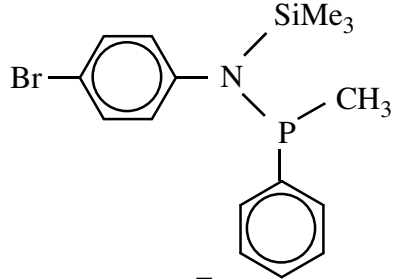
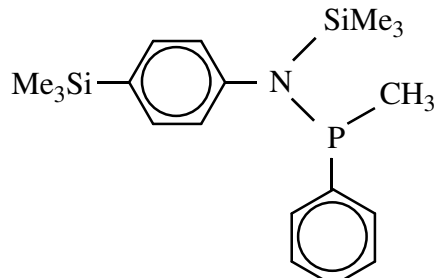
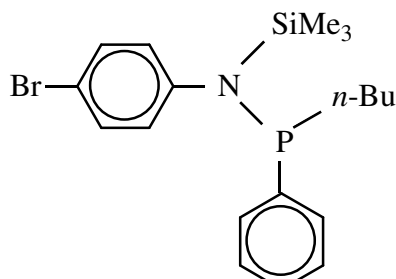
Table 7. Physical and Analytical Data for Compounds **1-17** and **22-28** (continued)

Compound	% Yield	bp, °C (mmHg)	% C (calc)	% H (calc)	% N (calc)
 16	66	140-145 °C (0.01)	53.37 (53.32)	8.12 (7.32)	5.69 (5.65)
 17	70	125-130 °C (0.01)	45.19 (44.69)	5.81 (5.44)	5.24 (5.21)
 22	61	120-125 °C (0.1)	36.61 (36.39)	4.01 (3.66)	4.30 (4.24)

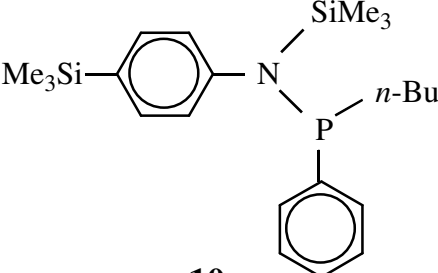
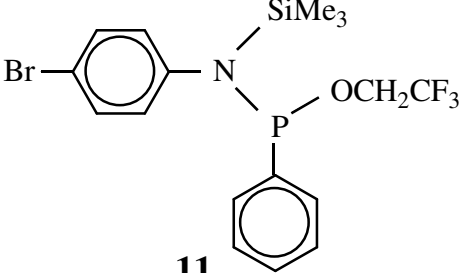
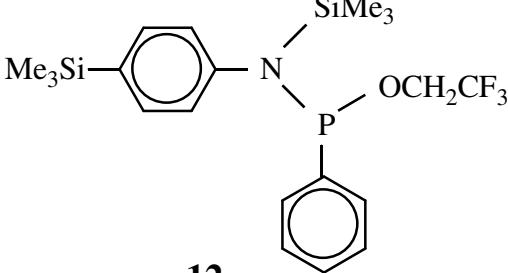
Table 7. Physical and Analytical Data for Compounds **1-17** and **22-28** (continued)

Compound	% Yield	bp, °C (mmHg)	% C (calc)	% H (calc)	% N (calc)
 <p>23</p>	70	90-94 °C (0.01)	28.98 (28.94)	2.05 (2.02)	2.85 (2.81)
 <p>24</p>	58	155-160 °C (0.1)	46.06 (45.94)	3.86 (3.60)	3.67 (3.57)
 <p>25</p>	36	147-150 °C (0.01)		<i>a</i>	

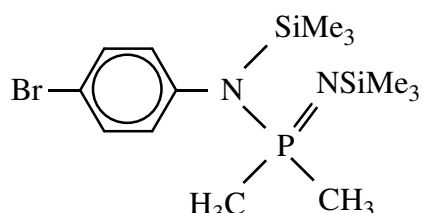
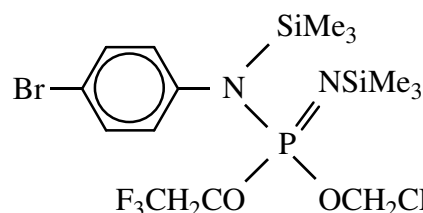
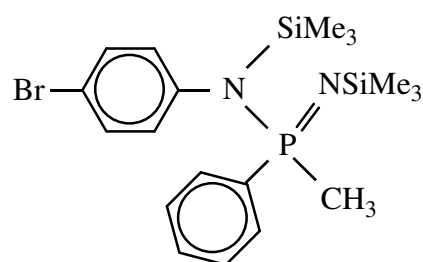
^a Not obtained due to presence of starting aniline reagent **D** as impurity

Table 7. Physical and Analytical Data for Compounds **1-17** and **22-28** (continued)

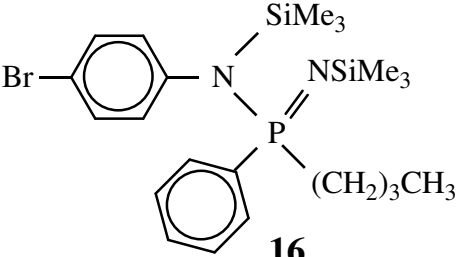
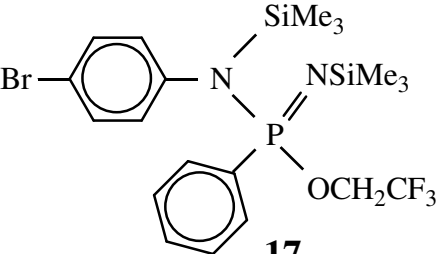
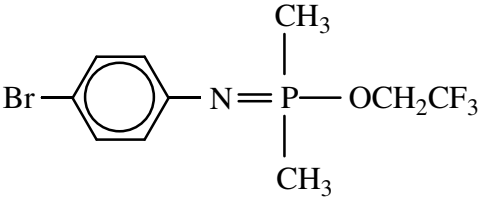
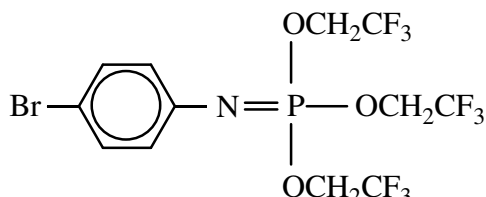
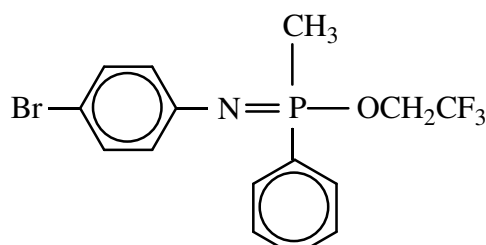
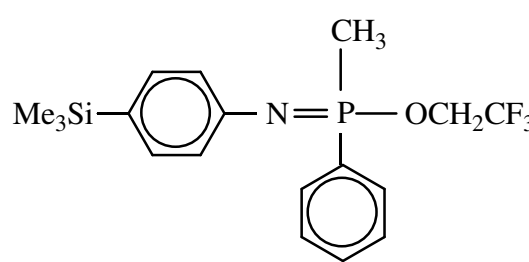
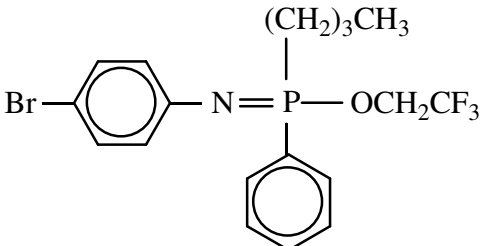
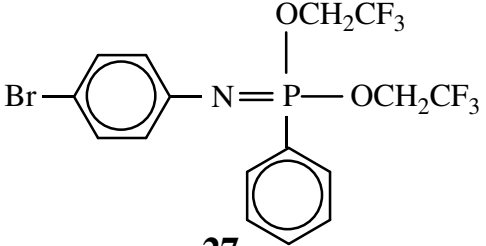
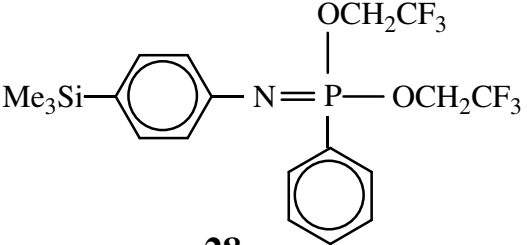
Compound	% Yield	bp, °C (mmHg)	% C (calc)	% H (calc)	% N (calc)
 <p>26</p>	65	150-153 °C (0.01)	49.73 (49.79)	5.11 (4.64)	3.25 (3.23)
 <p>27</p>	77	134-138 °C (0.01)	40.54 (40.36)	2.79 (2.75)	2.92 (2.94)
 <p>28</p>	30	130-138 °C (0.01)		<i>a</i>	

^a Not obtained due to the presence of starting aniline reagent **D** as impurity

SECTION TWO

SYNTHESIS AND REACTIVITY OF

(SILYLAMINO)(SILYLANILINO)PHOSPHINES AND SYNTHESIS

OF (DISILYLANILINO)PHOSPHINES

Introduction

As mentioned in the Literature Review, the Wilburn Method is the most convenient route for the synthesis of (silylamino)phosphines. Using the same general method, a series of novel (silylamino)(silylanilino)phosphines have been synthesized. These new types of phosphines can undergo oxidation reactions to produce the corresponding (silylanilino)phosphoranimines. Subsequently these phosphoranimines can undergo thermal condensation to yield polyphosphazenes. Due to the presence of bis(trimethylsilyl)amino groups, the phosphoranimines and polyphosphazenes can be potential precursors for cross-linking polyphosphazene polymers.

Recently, some poly(phenylenephosphazenes) were obtained by the bromination reactions of geminal (disilylanilino)phosphines.⁷³ However (disilylanilino)phosphines having two different substituents on the phosphorous atom have not been synthesized. The synthesis of some nongeminal (disilylanilino)phosphines by two different routes is reported here. The first method involves the synthesis of a chlorophosphine reagent, whereas the second method is a one-pot procedure which does not require the synthesis of chlorophosphines.

Results and Discussion

Synthesis of (Silylamino)(silylanilino)phosphines. The silyl aniline reagent **B** was synthesized according to the literature procedure.⁸⁴ Addition of one equivalent of *n*-BuLi to **B** gave the aryllithium intermediate **F**. The synthesis of phosphines was carried out by utilizing the Wilburn method.^{14c} Hexamethyldisilazene was lithiated by using *n*-BuLi, and then one equivalent of trichlorophosphine was added at $-78\text{ }^{\circ}\text{C}$ to give the dichloro-substituted phosphine intermediate. The *p*-lithiated silylaniline reagent **F** is sufficiently bulky to displace only one chlorine atom from the $-\text{PCl}_2$ intermediate to yield a disubstituted mono-chloro phosphine intermediate **G**. By substituting the remaining chlorine atom with various nucleophiles, a series of novel (silylamino)(silylanilino)-phosphines **32 – 37** were synthesized (eq 12)

Compound **32** is a colorless gel, phosphine **35** is a light yellow colored gel, and phosphines **33, 34, 36, 37** are colorless liquids. Phosphines **32 – 37** are moisture sensitive compounds that were purified by long-path vacuum distillation. These phosphines were fully characterized by ^1H , ^{13}C , and ^{31}P NMR spectroscopy (Table 8) and by elemental analysis (Table 12).

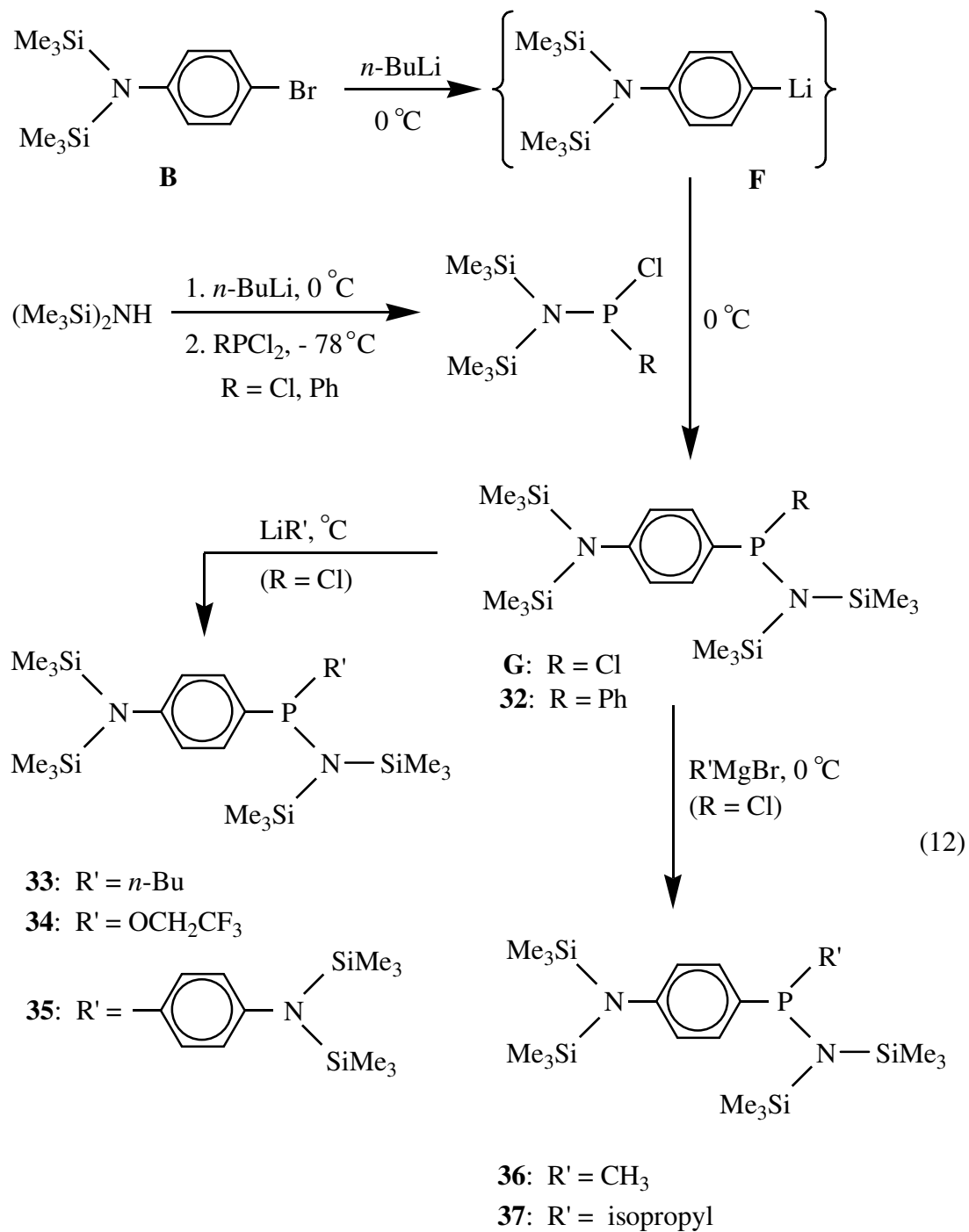

Reactivity of (Silylamino)(silylanilino)phosphines. The (silylamino)(silylanilino)phosphines **32** – **34** and **36** were treated with Br_2 to form the *P*-bromo phosphoranimine as a reactive intermediate. The subsequent nucleophilic substitution of *P*-bromo group by $\text{LiOCH}_2\text{CF}_3$ yielded phosphoranimines **38** – **41** (eq 13).

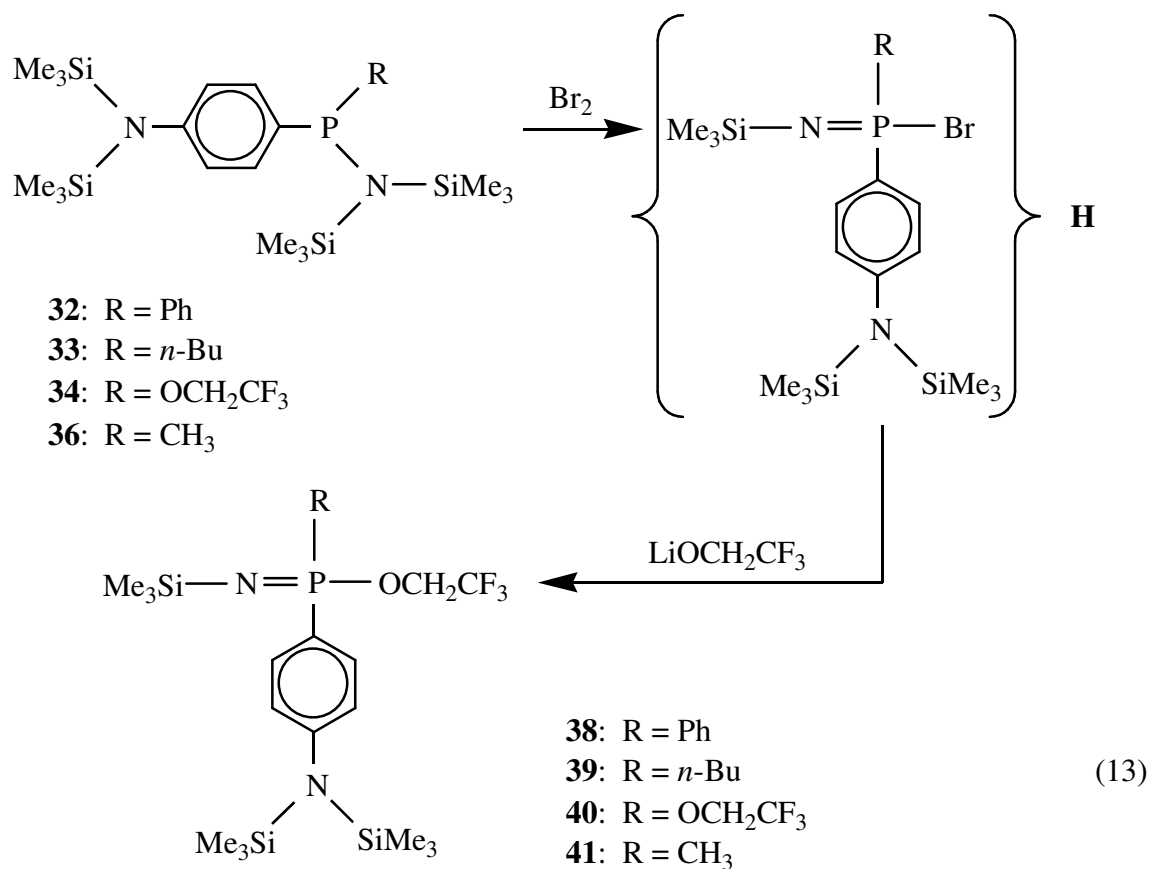

These N-silylphosphoranimines are moisture sensitive, colorless liquids that were purified by long-path vacuum distillation. All the compounds were characterized by ^1H , ^{13}C , and ^{31}P NMR spectroscopy (Table 9) and by elemental analysis (Table 12).

Thermal Condensation of *N*-Silylphosphoranimines 38-41. *N*-silylphosphoranimines **38-41** underwent thermal condensation to form phosphazene oligomers **42-45** respectively (eq 14). The condensation process was carried out by sealing the phosphoranimines in thick-walled glass ampules under high vacuum and heating at 200 °C for approximately two weeks. The ampules were opened and the volatile silyl ether was collected in a cold trap and identified by ^1H NMR.

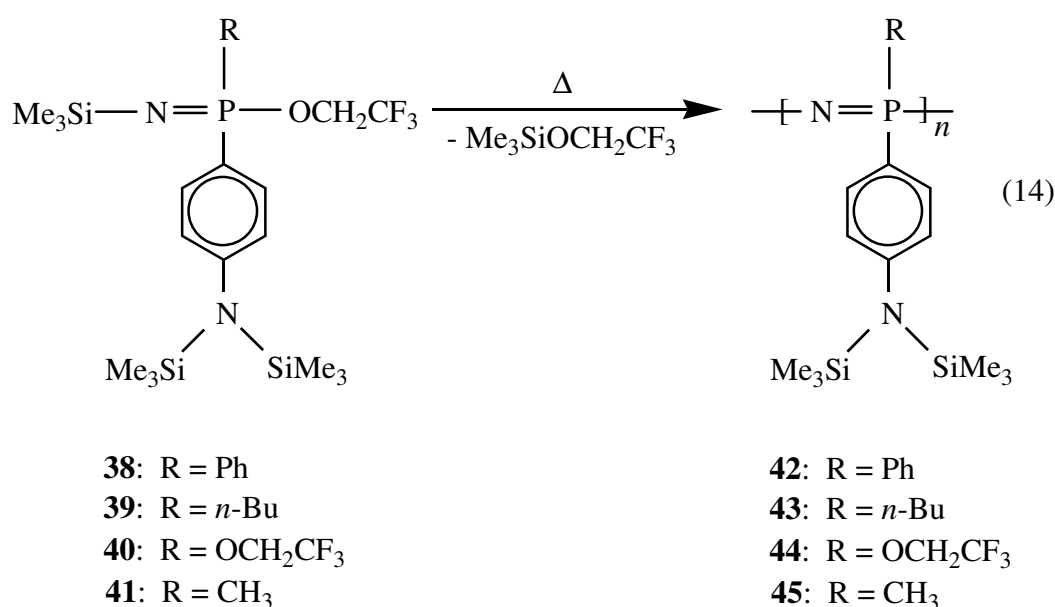

Phosphazenes **42** and **43** were purified by making a concentrated solution of the material in CH₂Cl₂ (15 mL) and then precipitating into hexane (300 mL). Phosphazenes **44** and **45** did not dissolve in CH₂Cl₂. The new products **42** and **43** were characterized by ^1H , ^{13}C , ^{31}P NMR spectroscopy (Table 10). Since these compounds have labile N-SiMe₃ groups, they are moisture sensitive materials and, when exposed to air, a sharp N-H signal is observed in ^1H NMR spectrum. Molecular weight data is not obtained for these oligomeric products due to their air-sensitivity and limited solubility.

Synthesis of (Disilylanilino)phosphines 46 and 47. The synthesis of phosphines **46** and **47** (eq 15) were carried out by a one-pot procedure similar to the Wilburn method.^{14c} Dichlorophenylphosphine was added at $-78\text{ }^{\circ}\text{C}$ to a solution of the lithium reagent to selectively replace one chlorine atom. The remaining chlorine atom was substituted by adding *n*-BuLi to give colorless liquid compound **46**. However due to the high reactivity of silylaniline reagent **F**, some amount of yellow colored gel (compound **47**) was also obtained. In order to selectively synthesize compound **47**, one half equivalent of PhPCl_2 was used. Compounds **46** and **47** are moisture sensitive compounds that were purified by long path vacuum distillation. These phosphines were fully characterized by ^1H , ^{13}C , and ^{31}P NMR spectroscopy (Table 11) and by elemental analysis (Table 12).

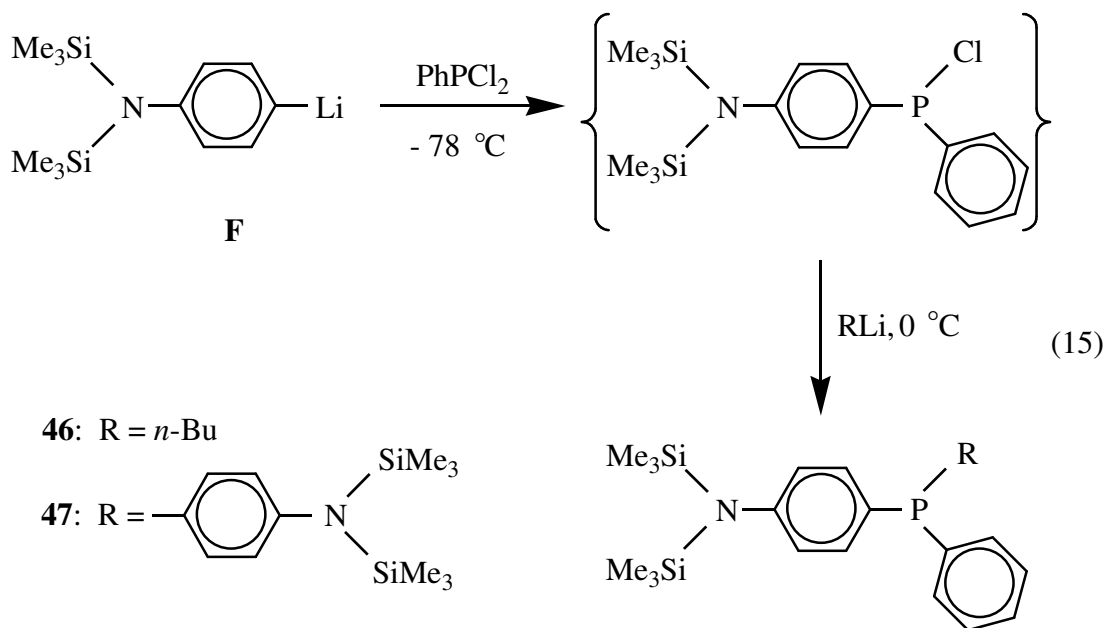

Synthesis of (Disilylanilino)phosphine 48. The silylaminophosphine **I** was synthesized according to the Wilburn method. The phosphine **I** was then treated with excess HCl (4 equivalents) to cleave N-Si and N-P bonds to give chlorophosphine reagent **J**, which was purified by long-path vacuum distillation. The addition of phosphine reagent **J** to a solution of **F** gave compound **48** (eq 16). Compound **48** was purified by long-path vacuum distillation and obtained as a colorless liquid. Phosphine **48** was fully characterized by ^1H , ^{13}C , and ^{31}P NMR spectroscopy (Table 11) and by elemental analysis (Table 12).

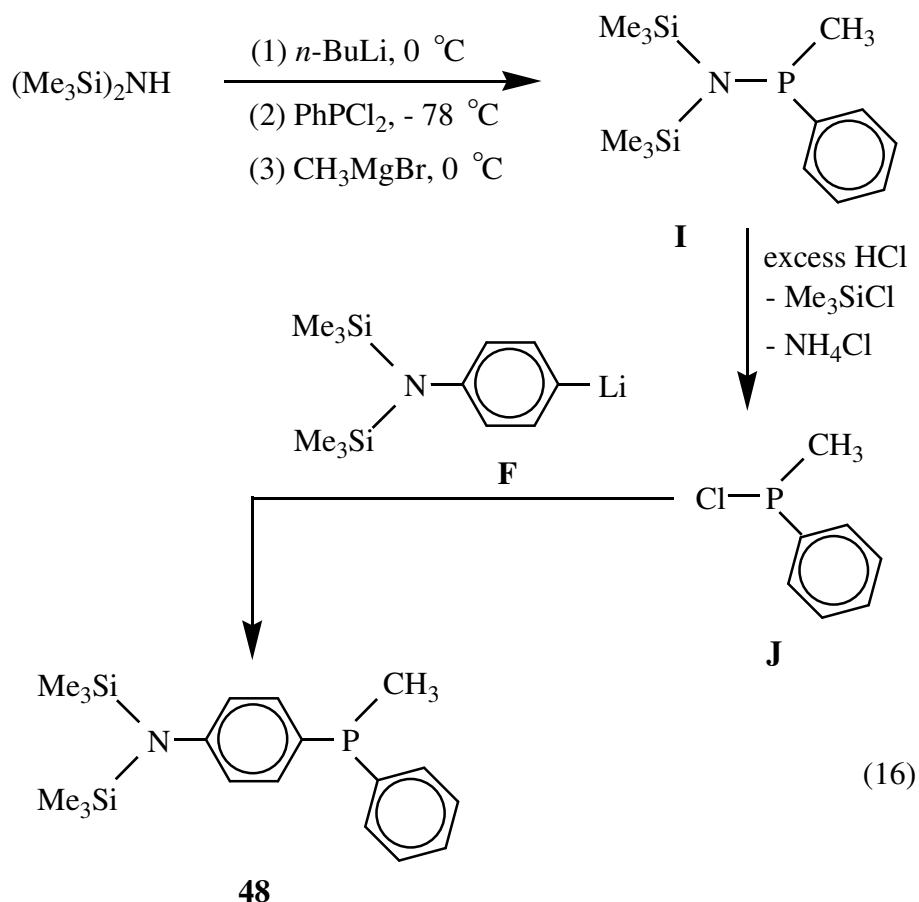

EXPERIMENTAL

Materials and general procedures. The following reagents were obtained from commercial sources and used without further purification: $(\text{Me}_3\text{Si})_2\text{NH}$, PCl_3 , PhPCl_2 , $p\text{-BrC}_6\text{H}_4\text{NH}_2$, Me_3SiCl , Br_2 , $\text{CF}_3\text{CH}_2\text{OH}$, HCl (1 M in ether), CH_3MgBr (3.0 M in ether), $i\text{-Pr}$ (2.0 M in ether) $n\text{-BuLi}$ (2.5 M in hexane). The (silylamino)phosphine, $(\text{Me}_3\text{Si})_2\text{NP}(\text{Ph})\text{Me}$ (**I**) was prepared according to the literature procedure¹⁵. The solvents Et_2O and hexane were distilled under N_2 from CaH_2 , the solvents CH_2Cl_2 and benzene were distilled under Argon from CaH_2 immediately prior to use. ^1H , $^{13}\text{C}\{^1\text{H}\}$, and $^{31}\text{P}\{^1\text{H}\}$ NMR spectra were recorded on a Varian XL-300 spectrometer using CDCl_3 as the solvent. Elemental analysis were performed by Schwarzkopf Microanalytical Laboratory, Inc, New York. All reactions and other manipulations were carried out under dry nitrogen or under vacuum unless otherwise specified.

Preparation of Silylaniline Reagent F. A 3-neck (500 mL) round-bottom flask equipped with a mechanical stirrer, N_2 inlet, and an additional funnel was charged with Et_2O (200 mL) and silylaniline **B** (16.38 g, 51.77 mmol). The reaction mixture was cooled to $0\text{ }^\circ\text{C}$ and $n\text{-BuLi}$ (24 mL, 60 mmol) was added slowly. The mixture was stirred at $0\text{ }^\circ\text{C}$ for at least one hour to give the solution of silylaniline reagent **F**.

Preparation of (Silylanilino)(silylamino)phosphines. Phosphines **32-37** were prepared according to the literature procedure.^{15, 16} A 3-neck (1000 mL) round-bottom flask, equipped with a mechanical stirrer, N_2 inlet, and an additional funnel was charged with Et_2O (200 mL) and $(\text{Me}_3\text{Si})_2\text{NH}$ (8.25 g, 51.11 mmol). The mixture was cooled to $0\text{ }^\circ\text{C}$ and $n\text{-BuLi}$ (24 mL, 60 mmol) was added slowly. The mixture was allowed to warm to

room temperature and was stirred for one hour. The mixture was cooled to $-78\text{ }^{\circ}\text{C}$ and PCl_3 (7.08 g, 51.57 mmol) was added slowly. The mixture was allowed to warm to room temperature and was stirred for two hours. The mixture was again cooled to $0\text{ }^{\circ}\text{C}$ and the pre-synthesized solution of **F** (51.77 mmol) was added slowly via a cannula. After the addition, the reaction mixture was allowed to warm to room temperature and was stirred for two hours to give solution **G**. To replace the remaining chlorine, the mixture was again cooled to $0\text{ }^{\circ}\text{C}$ and CH_3MgBr (17.33 mL, 52 mmol) was added slowly, the flask was warmed to room temperature, and was stirred for five hours. Solvents were removed under reduced pressure and hexane (300 mL) was added to precipitate the salt. The salt was removed by filtration and hexane was removed under reduced pressure. The product was distilled at $75\text{-}80\text{ }^{\circ}\text{C}$ (0.1 mmHg) to afford compound **36**.

For the preparation of compounds **32-35** and **37** the above procedure was followed except that PhPCl_2 was used instead of PCl_3 for the preparation of compound **32**. For the preparation of compounds **33**, **34**, and **37**, reagents *n*-BuLi, $\text{LiOCH}_2\text{CF}_3$, and *i*-PrMgBr were used respectively in place of CH_3MgBr . In the preparation of compound **35**, a pre-synthesized solution of **F** was used. Compounds **32-37** were stored under N_2 atmosphere.

Preparation of *N*-Silylphosphoranimines 38-41. The required phosphoranimines were synthesized according to the literature procedure.^{31, 32} A three-neck 1000 mL round bottom flask, equipped with a mechanical stirrer, a rubber septum, an N_2 inlet, and an additional funnel, was charged with compound **32** (20.20 g, 40.0 mmol) and benzene (200 mL). The mixture was cooled to $0\text{ }^{\circ}\text{C}$ and Br_2 (7.35 g, 46.0 mmol) dissolved in benzene (30 mL) was added dropwise. The reaction mixture was stirred at room temperature for two hours. Solvents were removed under reduced pressure and Et_2O (200 mL) was added

to yield a solution of **H**. A separate 3-neck, 500 mL round-bottom flask, equipped with a mechanical stirrer, an N₂ inlet, rubber septum and an additional funnel, was charged with CF₃CH₂OH (4.50 g, 45 mmol) and Et₂O (200 mL). The mixture was cooled to 0 °C and *n*-BuLi (18 mL, 45 mmol) was added slowly. The flask was allowed to warm to room temperature and was stirred for one hour to give a solution of LiOCH₂CF₃. The flask containing the solution **H** was cooled to 0 °C, and the solution of LiOCH₂CF₃ was added slowly. After the addition, the reaction mixture was allowed to warm to room temperature and stirred for 4 hours. Solvents were removed under reduced pressure and hexane (500 mL) was added to precipitate the salt. The salt was removed by filtration and hexane was removed under reduced pressure. Distillation of the product at 120-125 °C (0.1 mmHg), afforded compound **38**. Compounds **39-41** were prepared by the same procedure. The compounds were stored under N₂ atmosphere.

Thermal Condensation of *N*-Silylphosphoranimines 38-41. The thermal condensation of *N*-silylphosphoranimines was carried out according to the literature procedure⁴⁷ used for related compounds. Compound **39** (3.57 g, 7.0 mmol) was distilled into a thick-walled glass ampule (20 mL capacity) which was then sealed at the constriction with a torch. The ampule was covered with glass wool and kept in a steel pipe for safety and was heated in a thermo-regulated oven at 200 °C for two weeks. After cooling, the ampule was opened and the volatile byproduct Me₃SiOCH₂CF₃ (1.2 g, 5.6 mmol) was collected into a cold trap. The brown solid residue was dissolved in CH₂Cl₂ (≈ 10 mL) and then poured into hexane (≈ 200 mL). Drying under vacuum for 24 hours gave compound **43** (80 %). The polyphosphazenes **42**, **44**, **45** were prepared in the same

manner. Products **44** and **45** were not soluble in CH_2Cl_2 and CHCl_3 , and, therefore, not characterized by NMR.

Preparation of (Disilylanilino)phosphines 46. A 3-neck (1000 mL) round-bottom flask, equipped with a mechanical stirrer, N_2 inlet, and an additional funnel was charged with Et_2O (300 mL) and silylaniline reagent **B** (44.50 g, 140.80 mmol). The mixture was cooled to $0\text{ }^\circ\text{C}$ and *n*-BuLi (56.4 mL, 141.00 mmol) was added slowly. The mixture was allowed to warm to room temperature and was stirred for one hour. The mixture was cooled to $-78\text{ }^\circ\text{C}$ and PhPCl_2 (25.06 g, 140.00 mmol) was added slowly. The mixture was allowed to warm to $0\text{ }^\circ\text{C}$ and was stirred for 2 hours. Later *n*-BuLi (56 mL, 140.00 mmol) was added slowly. The mixture was allowed to warm to room temperature and was stirred for 3 hours. The ether was removed under reduced pressure and hexane was added to precipitate the salt. The salt was removed by filtration and hexane was removed under reduced pressure. The product was distilled at $140\text{-}144\text{ }^\circ\text{C}$ (0.1 mmHg) as a colorless liquid to afford compound **46**.

Preparation of (Disilylanilino)phosphines 47. A three-neck (1000 mL) round-bottom flask, equipped with a mechanical stirrer, N_2 inlet, and an additional funnel was charged with Et_2O (300 mL) and silylaniline reagent **B** (31.60 g, 100.00 mmol). The mixture was cooled to $0\text{ }^\circ\text{C}$ and *n*-BuLi (40.0 mL, 100.00 mmol) was added slowly. The mixture was allowed to warm to room temperature and was stirred for one hour. The mixture was cooled to $-78\text{ }^\circ\text{C}$ and PhPCl_2 (8.95 g, 50.00 mmol) was added slowly. The flask was allowed to warm to room temperature and was stirred for 4 hours. The ether was removed under reduced pressure and hexane was added to precipitate salt. The salt was

removed by filtration and hexane was removed under reduced pressure. Distillation of the product at 180-186 °C (0.01 mmHg) gave compound **47**.

Preparation of Chlorophosphine J. A 3-neck (1000 mL) round-bottom flask, equipped with a mechanical stirrer, N₂ inlet, and an additional funnel was charged with Et₂O (200 mL) and the (Silylamino)phosphine **I** (14.17 g, 50.0 mmol). The mixture was cooled to 0 °C and HCl (200 mL, 200 mmol) 1.0 M in Et₂O was added slowly. The mixture was allowed to warm to room temperature and was stirred for 4 hours. The ether was removed under reduced pressure and hexane was added to precipitate salt. The salt was removed by filtration and hexane was removed under reduced pressure. Distillation of the product at 38-42 °C (0.01 mmHg) gave chlorophosphine **J**.

Preparation of (Disilylanilino)phosphine 48. A 3-neck (1000 mL) round-bottom flask, equipped with a mechanical stirrer, N₂ inlet, and an additional funnel was charged with Et₂O (200 mL) and chlorophosphine **J** (7.93 g, 50.0 mmol). In another flask a solution of silylaniline reagent **F** (50.0 mmol) was synthesized. The mixture was cooled to -78 °C and the solution of chlorophosphine was added slowly via cannula. The mixture was then warmed to room temperature and was stirred for 4 hours. The ether was removed under reduced pressure and hexane was added to precipitate salt. The salt was removed by filtration and hexane was removed under reduced pressure. Distillation of the product at 135-139 °C (0.03 mmHg) gave disilylaminophosphine **48**.

Table 8. NMR Spectroscopic Data for Compounds **32-37**

Compound	Signal	¹ H NMR		¹³ C NMR		³¹ P NMR	
		δ	J _{PH}	δ	J _{PC}	δ	
 <p style="text-align: center;">32</p>	NSi(CH ₃) ₃	0.01(s)		0.13(s)			
	PNSi(CH ₃) ₃	0.02(s)		2.37(d)	7.0	48.90	
	NC ₆ H ₄	6.8-7.3(m)					
		C ₁			146.19(s)		
		C _{2,6}			128.45(d)	19.0	
		C _{3,5}			129.28(d)	19.6	
		C ₄			138.77(d)	23.4	
	PC ₆ H ₅	7.26-7.46(m)					
		C ₇			133.15(d)	21.2	
		C _{8,12}			127.60(d)	5.4	
		C _{9,11}			125.83(d)	5.0	
		C ₁₀			125.41(s)		

Table 8. NMR Spectroscopic Data for Compounds **32-37** (continued)

Compound	Signal	¹ H NMR		¹³ C NMR		³¹ P NMR	
		δ	J _{PH}	δ	J _{PC}	δ	
 <p style="text-align: center;">33</p>	NSi(CH ₃) ₃	0.01(s)		0.00(s)			
	PNSi(CH ₃) ₃	0.09(s)		2.26(d)	6.6	47.64	
	CH ₂ CH ₃	0.94(t)	6.6	11.90(s)			
	CH ₂ CH ₂ CH ₂	1.5-1.5(m)		22.41(d)	13.6		
	CH ₂ CH ₂ CH ₂	1.5-1.5(m)		26.24(d)	20.3		
	CH ₂ CH ₂ CH ₂	1.9-2.0(m)		29.48(d)	21.2		
	NC ₆ H ₄	6.8-7.2(m)					
		C ₁			144.82(s)		
		C _{2,6}			127.67(s)		
		C _{3,5}			127.07(d)	15.2	
C ₄				138.77(d)	21.6		

Table 8. NMR Spectroscopic Data for Compounds **32-37** (continued)

Compound	Signal	¹ H NMR		¹³ C NMR		³¹ P NMR
		δ	J _{PH}	δ	J _{PC}	δ
<p style="text-align: center;">34</p>	NSi(CH ₃) ₃	0.01(s)		0.00(s)		
	PNSi(CH ₃) ₃	0.11(s)		1.94(d)	7.2	150.18
	OCH ₂ CF ₃	4.1-4.2(m)		63.91(dq)	27.5	
					35.2 ^a	
	OCH ₂ CF ₃			<i>b</i>		
	NC ₆ H ₄	6.8-7.3(m)				

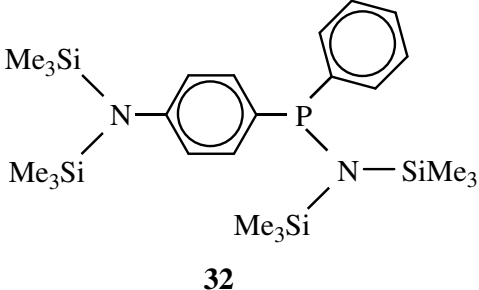
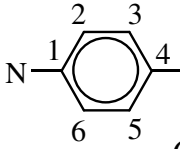
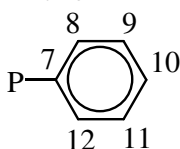
^a J_{FC} value^b Not observed

Table 8. NMR Spectroscopic Data for Compounds **32-37** (continued)

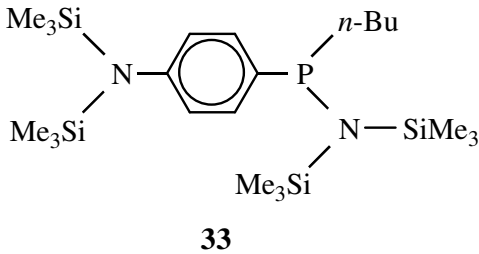
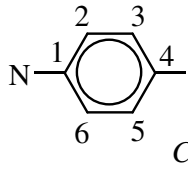
Compound	Signal	¹ H NMR		¹³ C NMR		³¹ P NMR	
		δ	J _{PH}	δ	J _{PC}	δ	
 <p style="text-align: center;">35</p>	NSi(CH ₃) ₃	0.02(s)		-0.01(s)			
	PNSi(CH ₃) ₃	0.08(s)		2.23(d)	7.2	48.89	
	PC ₆ H ₄	6.8-7.3(m)					
	C ₁			146.68(s)			
	C _{2,6}			127.36(s)			
	C _{3,5}			128.92(d)	19.6		
C ₄			133.09(d)	21.0			

Table 8. NMR Spectroscopic Data for Compounds **32-37** (continued)

Compound	Signal	¹ H NMR		¹³ C NMR		³¹ P NMR
		δ	J _{PH}	δ	J _{PC}	δ
 <p style="text-align: center;">36</p>	NSi(CH ₃) ₃	0.01(s)		0.00(s)		
	PNSi(CH ₃) ₃	0.08(s)		2.13(s)		38.53
	CH ₃	1.56(d)	5.7	14.92(d)	25.0	
	NC ₆ H ₄	6.8-7.1(m)				
		C ₁			144.82(s)	
	C _{2,6}			127.68(s)		
	C _{3,5}			126.93(d)	15.8	
	C ₄			139.21(d)	18.3	

Table 8. NMR Spectroscopic Data for Compounds **32-37** (continued)

Compound	Signal	¹ H NMR		¹³ C NMR		³¹ P NMR
		δ	J _{PH}	δ	J _{PC}	δ
 <p style="text-align: center;">37</p>	NSi(CH ₃) ₃	0.00(s)		0.14(s)		
	PNSi(CH ₃) ₃	0.08(s)		2.45(d)	6.6	57.77
	CH(CH ₃) ₂	1.07(dd)	21.9	17.46(d)	11.2	
	(CH ₃) _A		6.9 ^b			
	CH(CH ₃) ₂	1.15(dd)	16.2	18.83(d)	37.6	
	(CH ₃) _B		6.3 ^b			
	CH(CH ₃) ₂	2.35(ds) ^a	6.6	24.67(d)	18.4	
			6.9 ^b			
	NC ₆ H ₄	6.7-7.3(m)				
						
	C ₁			145.56(s)		
	C _{2,6}			127.70(s)		
	C _{3,5}			128.86(d)	15.5	
	C ₄			135.97(d)	23.6	

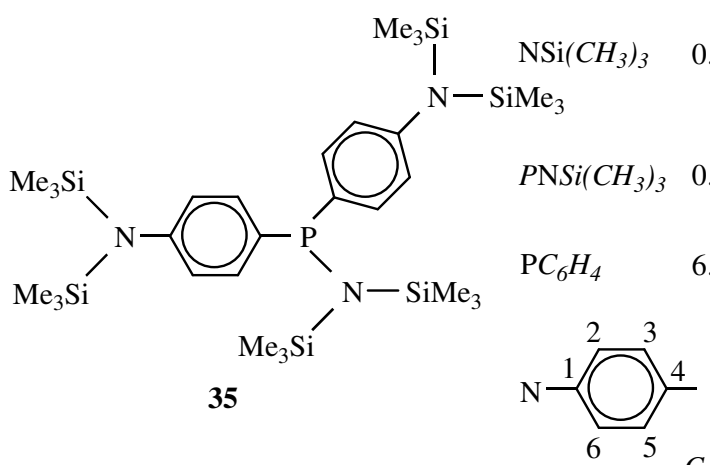
(CH₃)_A and (CH₃)_B are diastereotopic

^a ds - doublet of septets

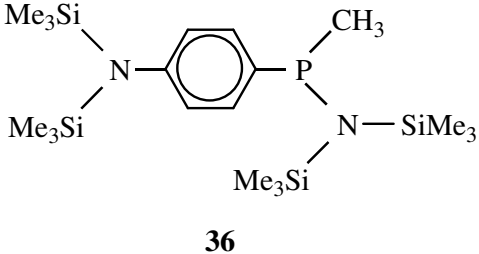
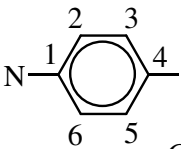
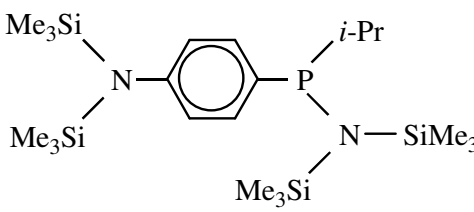
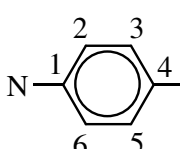
^b J_{HH} value

Table 9. NMR Spectroscopic Data for Compounds **38-41**

Compound	Signal	¹ H NMR		¹³ C NMR	³¹ P NMR		
		δ	J _{PH}	δ	J _{PC}	δ	
<p style="text-align: center;">38</p>	N[Si(CH ₃) ₃] ₂	0.07(s)		0.00(s)			
	NSi(CH ₃) ₃	0.09(s)		1.16(d)	3.5		
	POCH ₂ CF ₃	4.2-4.3(m)		57.44(dq)	36.9	17.13	
	OCH ₂ CF ₃			<i>a</i>			
	NC ₆ H ₄	6.9-7.4(m)					
		<i>C</i> ₁			150.16(s)		
		<i>C</i> _{2,6}			126.18(d)	13.6	
		<i>C</i> _{3,5}			129.96(s)		
		<i>C</i> ₄			113.53(d)	14.4	
		PC ₆ H ₅	6.9-7.8(m)				
		<i>C</i> ₇			131.19(d)	12.4	
		<i>C</i> _{8,12}			127.71(d)	14.3	
		<i>C</i> _{9,11}			129.65(d)	23.3	
<i>C</i> ₁₀				129.35(s)			

^a not observed

Table 9. NMR Spectroscopic Data for Compounds **38-41** (continued)

Compound	Signal	¹ H NMR		¹³ C NMR		³¹ P NMR	
		δ	J _{PH}	δ	J _{PC}	δ	
<p style="text-align: center;">39</p>	N[Si(CH ₃) ₃] ₂	0.00(s)		0.00(s)			
	NSi(CH ₃) ₃	0.01(s)		1.54(s)			
	CH ₂ CH ₂ CH ₃	0.76(t)	7.2	11.52(s)			
	CH ₂ CH ₂ CH ₂	1.2-1.3(m)		21.62(d)	17.0		
	CH ₂ CH ₂ CH ₂	1.2-1.3(m)		22.31(d)	2.6		
	PCH ₂	1.7-1.8(m)		29.68(d)	95.1	29.14	
	OCH ₂ CF ₃	3.8-3.9(m)		57.20(dq)	4.9		
		4.1-4.2(m)			36.5 ^a		
	OCH ₂ CF ₃			<i>b</i>			
	NC ₆ H ₄	6.9-7.5(m)					
		<i>C</i> ₁			150.20(d)	3.2	
		<i>C</i> _{2,6}			129.88(d)	10.9	
	<i>C</i> _{3,5}			127.81(d)	13.8		
	<i>C</i> ₄			123.47(d)	9.8		

^a J_{FC} value
^b not observed

Table 9. NMR Spectroscopic Data for Compounds **38-41** (continued)

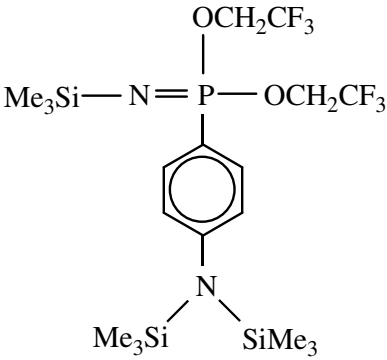
Compound	Signal	¹ H NMR		¹³ C NMR		³¹ P NMR	
		δ	J _{PH}	δ	J _{PC}	δ	
 <p style="text-align: center;">40</p>	N[Si(CH ₃) ₃] ₂	0.00(s)		0.00(s)			
	NSi(CH ₃) ₃	0.01(s)		0.95(d)		3.5	
	POCH ₂ CF ₃	4.1-4.2(m)		59.31(dq)		5.2	8.80
							37.1 ^a
	OCH ₂ CF ₃			121.08(dq)		24.4	
							278.1 ^a
	NC ₆ H ₄	6.9-7.5(m)					

^a J_{FC} value

Table 9. NMR Spectroscopic Data for Compounds **38-41** (continued)

Compound	Signal	¹ H NMR		¹³ C NMR		³¹ P NMR
		δ	J _{PH}	δ	J _{PC}	δ
<p style="text-align: center;">41</p>	N[Si(CH ₃) ₃] ₂	0.00(s)		0.00(s)		
	NSi(CH ₃) ₃	0.00(s)		1.38(d)	3.5	
	<i>P</i> CH ₃	1.60(d)	14.1	16.71(d)	94.9	26.22
	OCH ₂ CF ₃	3.8-3.9(m)		57.19(dq)	4.7	
		4.2-4.3(m)			32.1 ^a	
	OCH ₂ CF ₃			<i>b</i>		
	NC ₆ H ₄	6.9-7.5(m)				

^a J_{FC} value^b not observed

Table 10. NMR Spectroscopic Data for Compounds **42** and **43**

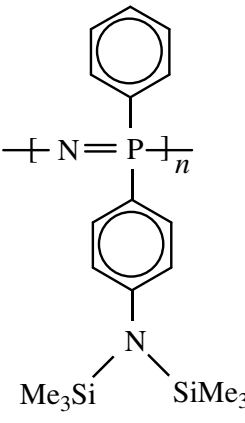
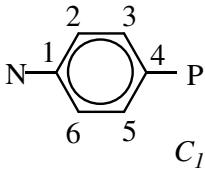
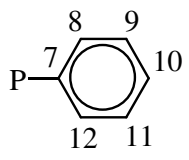
Compound	Signal	¹ H NMR		¹³ C NMR		³¹ P NMR	
		δ	J _{PH}	δ	J _{PC}	δ	
 <p style="text-align: center;">42</p>	NSi(CH ₃) ₃	0.03(s)					
	NC ₆ H ₄	6.4-7.9(m) ^a					
		C ₁					
		C _{2,6}					
		C _{3,5}					
		C ₄					
	PC ₆ H ₅	6.40-7.89(m) ^a					22.09
		C ₇					
		C _{8,12}					
		C _{9,11}					
	C ₁₀						

^a broad reonance¹³C not obtained even after 20,000 scans

Table 10. NMR Spectroscopic Data for Compounds **42** and **43** (continued)

Compound	Signa	¹ H NMR		¹³ C NMR	³¹ P NMR		
		δ	J _{PH}	δ	J _{PC}	δ	
 <p style="text-align: center;">43</p>	NSi(CH ₃) ₃	0.05(d)	11.7	1.84(d)	12.4		
	CH ₂ CH ₂ CH ₃	0.79(t)	1.8	13.61(s)			
	CH ₂ CH ₂ CH ₃	1.2-1.3(m)		24.12(d)	16.1		
	PCH ₂ CH ₂	1.2-1.3(m)		24.86(d)	3.9		
	PCH ₂	1.7-1.7(m)		31.36(d)	93.0	34.03	
	NC ₆ H ₄	6.6-7.5(m)					
		C ₁			150.31(s)		
		C _{2,6}			132.89(s)		
		C _{3,5}			133.53(d)	10.6	
		C ₄			114.19(d)	12.9	

Table 11. NMR Spectroscopic Data for Compounds **46-48**

Compound	Signal	¹ H NMR		¹³ C NMR		³¹ P NMR	
		δ	J _{PH}	δ	J _{PC}	δ	
 <p style="text-align: center;">46</p>	NSi(CH ₃) ₃	0.01(s)		0.00(s)			
	CH ₂ CH ₂ CH ₃	8.35(t)	6.3	11.73(s)			
	CH ₂ CH ₂ CH ₃	1.3-1.4(m)		22.22(d)	13.3		
	CH ₂ CH ₂ CH ₂	1.3-1.4(m)		26.07(d)	10.6		
	PCH ₂	1.9-2.0(m)		26.18(d)	4.9	-16.16	
	PC ₆ H ₄	6.8-7.2(m)					
		C ₁			146.77(s)		
		C _{2,6}			126.01(s)		
		C _{3,5}			128.08(s)		
		C ₄			127.05(d)	140.5	
	PC ₆ H ₅	7.2-7.3(m)					
		C ₇			131.11(d)	19.0	
		C _{8,12}			130.32(d)	17.9	
		C _{9,11}			126.20(s)		
		C ₁₀			92.00(s)		

Table 11. NMR Spectroscopic Data for Compounds **46-48** (continued)

Compound	Signal	¹ H NMR		¹³ C NMR		³¹ P NMR	
		δ	J _{PH}	δ	J _{PC}	δ	
 <p style="text-align: center;">47</p>	NSi(CH ₃) ₃	0.00(s)		0.00(s)			
	PC ₆ H ₄	6.8-7.0(m)				-6.96	
	 C ₁			146.84(s)			
	C _{2,6}			129.43(d)	8.7		
	C _{3,5}			131.76(d)	19.9		
	C ₄			113.01(d)	8.1		
	PC ₆ H ₅	7.2-7.3(m)					
	 C ₇			136.31(d)	10.9		
	C _{8,12}			131.41(d)	19.2		
	C _{9,11}			128.06(s)			
C ₁₀			126.23(s)				

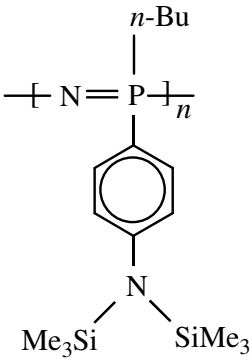
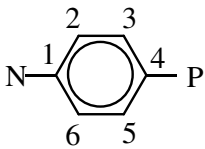
Table 11. NMR Spectroscopic Data for Compounds **46-48** (continued)

Compound	Signal	¹ H NMR		¹³ C NMR		³¹ P NMR	
		δ	J _{PH}	δ	J _{PC}	δ	
 <p style="text-align: center;">48</p>	NSi(CH ₃) ₃	0.00(s)		0.00(s)			
	PCH ₃	1.54(d)	3.6	10.78(d)	13.3	-27.05	
	PC ₆ H ₄	6.8-7.2(m)					
		C ₁			146.72(s)		
		C _{2,6}			130.49(d)	19.6	
		C _{3,5}			131.47(d)	9.5	
		C ₄			126.09(d)	22.2	
	PC ₆ H ₅	7.2-7.3(m)					
		C ₇			139.13(d)	12.4	
		C _{8,12}			128.05(d)	7.2	
	C _{9,11}			129.70(d)	18.1		
	C ₁₀			126.15(s)			

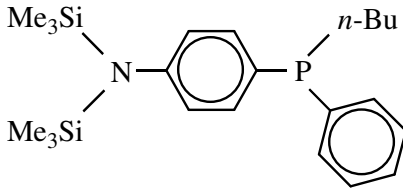
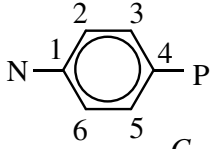
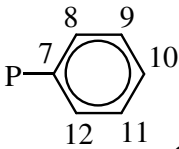
Table 12. Physical and Analytical Data for Compounds **32-41** and **46-48**

Compound	% Yield	bp, °C (mmHg)	% C (calc)	% H (calc)	% N (calc)
 <p style="text-align: center;">32</p>	58	149-152 °C (0.1)	54.47 56.93 (57.09)	9.43 9.92 (8.98)	5.34 5.46 (5.55)
 <p style="text-align: center;">33</p>	59	128-133 °C (0.1)	53.27 (54.48)	10.87 (10.18)	5.62 (5.77)
 <p style="text-align: center;">34</p>	60	93-96 °C (0.1)	45.73 (45.59)	7.84 (8.03)	5.56 (5.32)

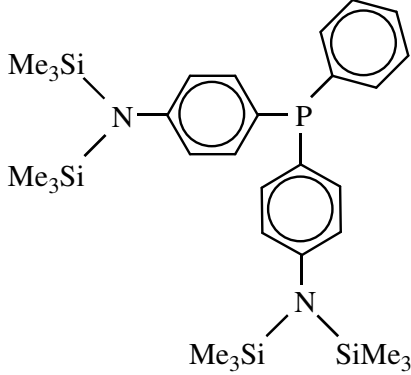
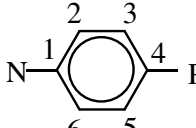
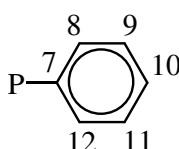
Table 12. Physical and Analytical Data for Compounds **32-41** and **46-48** (continued)

Compound	% Yield	bp, °C (mmHg)	% C (calc)	% H (calc)	% N (calc)
<p style="text-align: center;">35</p>	46	170-180 °C (0.01)	50.54 (54.24)	9.17 (9.41)	5.51 (6.33)
<p style="text-align: center;">36</p>	62	75-80 °C (0.1)	51.93 (51.52)	10.88 (9.78)	6.23 (6.32)
<p style="text-align: center;">37</p>	50	130-135 °C (0.01)	52.41 (53.56)	10.26 (10.06)	5.83 (5.95)

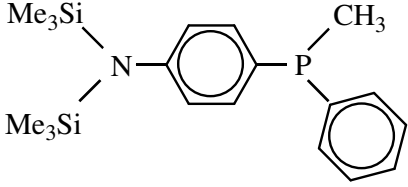
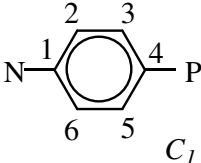
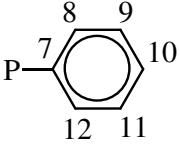
Table 12. Physical and Analytical Data for Compounds **32-41** and **46-48** (continued)

Compound	% Yield	bp, °C (mmHg)	% C (calc)	% H (calc)	% N (calc)
 <p style="text-align: center;">38</p>	52	120-124 °C (0.1)	51.68 (52.04)	7.12 (7.21)	5.42 (5.27)
 <p style="text-align: center;">39</p>	54	105-111 °C (0.01)	49.44 (49.38)	9.07 (8.29)	5.48 (5.48)

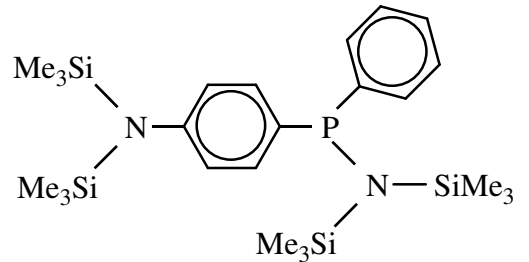
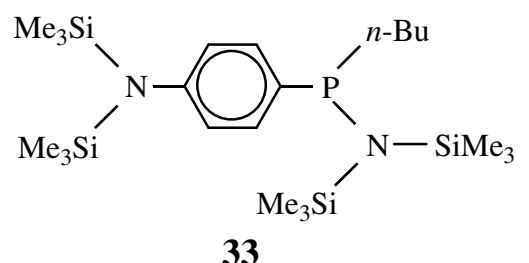
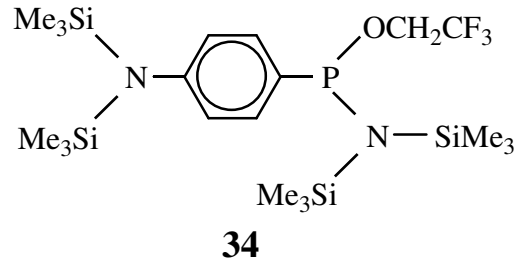
Table 12. Physical and Analytical Data for Compounds **32-41** and **46-48** (continued)

Compound	% Yield	bp, °C (mmHg)	% C (calc)	% H (calc)	% N (calc)
 40	55	105-108 °C (0.01)	41.05 (41.29)	6.69 (6.38)	5.14 (5.07)
 41	52	74-78 °C (0.1)	46.27 (46.12)	8.28 (7.74)	6.05 (5.97)

Table 12. Physical and Analytical Data for Compounds **32-41** and **46-48** (continued)

Compound	% Yield	bp, °C (mmHg)	% C (calc)	% H (calc)	% N (calc)
 <p>46</p>	50	140-144 °C (0.01)	65.51 (65.78)	9.98 (9.03)	3.27 (3.49)
 <p>47</p>	55	180-186 °C (0.01)	62.20 (62.01)	5.45 (8.50)	4.22 (4.82)
 <p>48</p>	62	135-139 °C (0.03)	63.25 (63.46)	9.19 (8.41)	3.78 (3.90)

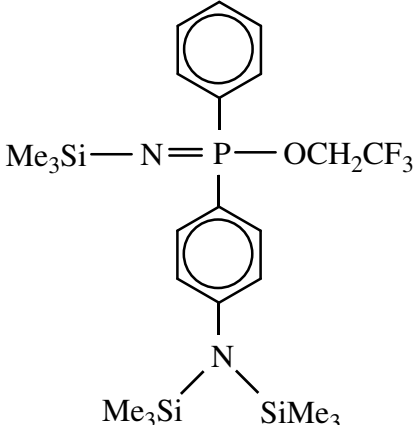
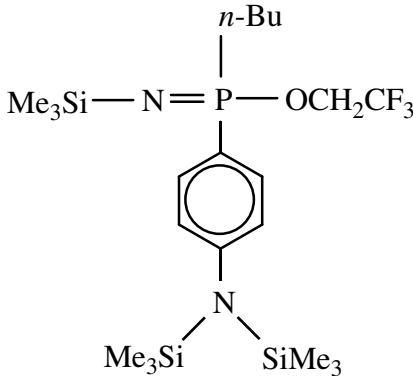
Concluding Remarks

The desirable chemical and physical properties of polyphosphazenes have made these materials potentially useful in a variety of applications. In this study on related systems, some (silylanilino)phosphines have been synthesized. The oxidation reactions of these phosphines with Me_3SiN_3 , CH_3I , and Br_2 have yielded the corresponding phosphoranimines that may serve as precursor molecules for the synthesis of new materials. These phosphoranimines containing $N\text{-SiMe}_3$ and $P\text{-OCH}_2\text{CF}_3$ groups underwent thermal condensation to yield materials containing the $N\text{-SiMe}_3$ functional group attached to phosphorus along the backbone. The phosphoranimines that have a $P\text{-OCH}_2\text{CF}_3$ and a silyl group on the para position of the aniline ring might undergo thermal condensation to yield the highly desirable poly(phenylenephosphazene) systems.

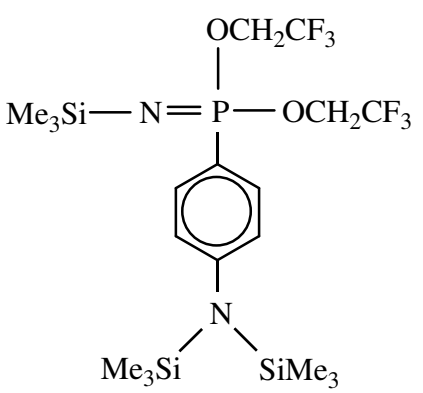
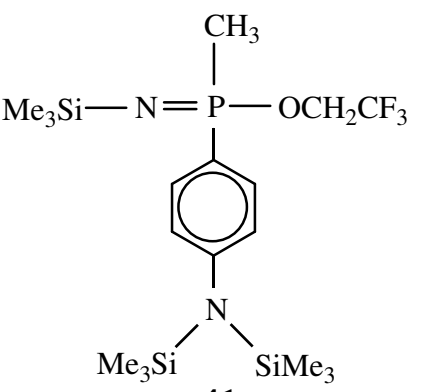
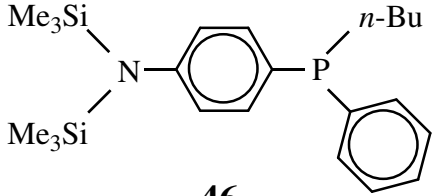
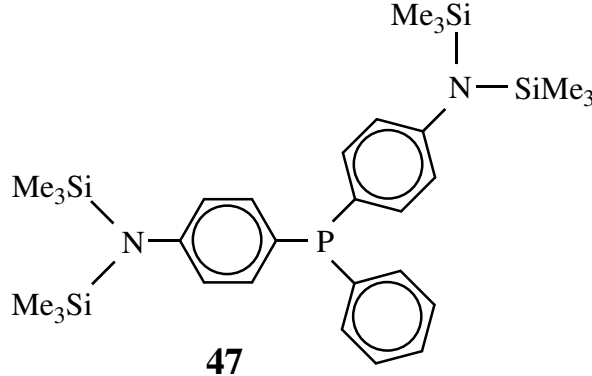
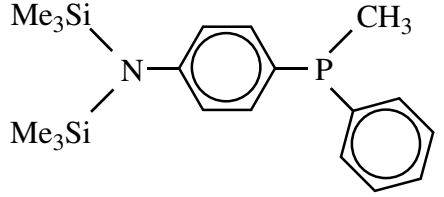
Some (silylamino)(silylanilino)phosphines were also synthesized. Their oxidation reactions produced the corresponding phosphoranimines that underwent thermal condensation to form novel phosphazene products. Although these materials are not completely characterized, structurally they have the reactive $\text{N}(\text{SiMe}_3)_2$ groups attached to phosphorous through a phenylene spacer group. Further reactions with suitable monomers might lead to new cross-linked polymers. Some novel (silylanilino)phosphines with mixed substituents on the phosphorous atom have also been synthesized in a one-pot procedure. All of these phosphines and phosphoranimines are fully characterized and many are potential candidates for the synthesis of novel poly(phenylenephosphazenes) or other materials with potentially useful properties. Considering the wide applications and the ease of tuning of the properties of these materials by changing the side groups or by

introducing spacer groups into the polymer backbone, the chemistry of these precursors to inorganic and organic hybrid materials is worthy of further research.

References

1. (a) Wessling, R. A. *J. Polym. Sci., Polym. Symp.* **1985**, 72, 55. (b) Lenz, R. W.; Han, C. C.; Stenger-Smith, J.; Karasz, F. E. *J. Polym. Sci., Part A* **1988**, 26, 3241. (c) Borroughes, J. H.; Bradley, D. D. C.; Brown, A. R.; Marks, R. N.; MacKay, K.; Friend, R. H.; Burn, P. L.; Holmes, A. B. *Nature* **1990**, 347, 539.
2. (a) Mark, J.E.; Allcock, H.R.; West, R. *Inorganic polymers*; Prentice hall: Englewood Cliff, NJ, **1992**. (b) Allcock, H. R. *Chemistry and Applications of polyphosphazenes*; John Wiley & Sons, **2003**.
3. Wisian-Neilson, P. In *Encyclopedia of Inorganic Chemistry, Vol. 6*, 3371; King, R. B., Ed.; John Wiley & Sons: Chichester, England, **1994**.
4. (a) Allcock, H.R. *Science* **1992**, 255, 1106. (b) Allcock, H. R. *Angew. Chem. Int. Ed. Engl.* **1977**, 16, 147. (c) Allcock, H. R. *Phosphorous-Nitrogen Compounds*; Academic: New York, 1972. (d) Allcock, H. R. *ACS Symposium Ser.* **1988**, 360, 250.
5. Neilson, R. H.; Wisian-Neilson, P. *Chem. Rev.* **1988**, 88, 541.
6. Allcock, H. R.; Kugel, R. L. *J. Am. Chem. Soc.* **1965**, 87, 4216.
7. Wisian-Neilson, P.; Neilson, R.H. *J. Am. Chem. Soc.* **1980**, 102, 2848
8. Neilson, R. H.; Wisian-Neilson, P. *J. Macromol. Sci. Chem.* **1981**, A16, 425.
9. Neilson, R. H.; Klaehn, J. R. *J. Inorg. Organomet. Polymers*, **2006**, 16, 319.

10. Neilson, R. H.; Wang, B. *J. Inorg. Organomet. Polym.*, **2007**, *17*, 407.
11. Herring, D. L. *J. Org. Chem.* **1961**, *26*, 3998.
12. Pomerantz, M.; Victor, M. W. *Macromolecules* **1989**, *22*, 3512.
13. Escobar, M.; Jin, Z.; Lucht, B. L. *Organic Letters* **2002**, *4*, 2213.
14. (a) Noth, H.; Menial, L. Z. *Anorg. Allg. Chem.* **1967**, *349*, 225. (b) Keat, R. *J. Chem. Soc. (A)* **1970**, 1795. (c) Wilburn, J. C.; Neilson, R. H. *Inorg. Chem.* **1977**, *16*, 2519. (d) Neilson, R. H.; Lee, R. C.-Y.; Cowley, A. H. *Inorg. Chem.* **1977**, *16*, 1455.
15. (a) Wilburn, J. C.; Neilson, R. H. *Inorg. Chem.* **1979**, *18*, 347. (b) Neilson, R. H.; Wisian-Neilson, P. *Inorg. Chem.* **1982**, *21*, 3568. (c) Wisian-Neilson, P.; Neilson, R. H. *Inorg. Synth.* **1989**, *25*, 69.
16. Neilson, R. H. *Inorg. Chem.* **1981**, *20*, 1679.
17. (a) O' Neal, H. R.; Neilson, R. H. *Inorg. Chem.* **1983**, *22*, 814. (b) Ji, J.; Narayan-Sarathy, S.; Neilson, R. H.; Oxley, J. D.; Babb, D. A.; Rondan, N. G.; Smith, D. W. Jr. *Organometallics* **1998**, *17*, 783.
18. Staudinger, H.; Meyer, J. *Helv. Chem. Acta.* **1919**, *2*, 635.
19. West, R.; Thayer, J. S. *J. Am. Chem. Soc.* **1962**, *84*, 1763.
20. Wiberg, N.; Neruda, B. *Chem. Ber.* **1966**, *99*, 740.

21. (a) Appel, R.; Milker, R. *Chem. Ber.* **1974**, *107*, 2658. (b) Appel, R.; Ruppert, I. *Chem. Ber.* **1975**, *108*, 919.
22. (a) Scherer, O. J.; Klunsmann, P. *Z. Anorg. Allg. Chem.* **1969**, *370*, 171. (b) Scherer, O. J.; Schieder, G. *Chem. Ber.* **1968**, *101*, 4184.
23. Wilburn, J. C.; Wisian-Neilson, P.; Neilson, R. H. *Inorg. Chem.* **1979**, *18*, 1429.
24. Gololobov, Y. G.; Zhmurova, I. N.; Kasukhin, L. F. *Tetrahedron* **1981**, *37*, 437.
25. Gololobov, Y. G.; Kasukhin, L. F. *Tetrahedron* **1992**, *48*, 1353.
26. Niecke, E.; Flick, W. *Angew. Chem. Int. Ed. Engl.* **1974**, *13*, 134.
27. Neilson, R. H.; Wisian-Neilson, P.; Wilburn, J. C. *Inorg. Chem.* **1980**, *19*, 413.
28. Morton, D. W.; Neilson, R. H. *Organometallics* **1982**, *1*, 289.
29. Morton, D. W.; Neilson, R. H. *Organometallics* **1982**, *1*, 623.
30. (a) Appel, R.; Peters, J.; Schmitz, R. *Z. Anorg. Allg. Chem.* **1981**, *18*, 475. (b) Kolodiazhnyi, O. I. *Tetrahedron Lett.* **1980**, *21*, 3983.
31. (a) Li, B. -L.; Engenito, Jr., J. S.; Neilson, R. H.; Wisian-Neilson, P. *Inorg. Chem.* **1983**, *22*, 575. (b) Ford, R. R.; Goodman, M. A.; Neilson, R. H.; Roy, A. K.; Wettermark, U. G.; Wisian-Neilson, P. *Inorg. Chem.* **1984**, *23*, 2063.
32. (a) Wisian-Neilson, P.; Neilson, R. H. *Inorg. Chem.* **1980**, *19*, 1875. (b) Hani, R.; Jinkerson, D. L.; Wood, C. E.; Neilson, R. H. *Phosphorous, Sulfur, and Silica*, **1989**, *41*, 159.

33. Neilson, R. H.; Jinkerson, D. L.; Kucera, W. R.; Longlet, J. J.; Samuel, R. C.; Wood, C. E. *ACS Symposium Series*, **1994**, 572, 232.
34. Schmidbaur, H.; Jonas, G. *Chem. Ber.* **1967**, 100, 1120.
35. (a) Roy, A. K.; Wettermark, U. G.; Scheide, G. M.; Wisian-Neilson, P.; Neilson, R. H. *Phosphorous Sulfur* **1987**, 33, 147. (b) Roy, A. K.; Hani, R.; Neilson, R. H.; Wisian-Neilson, P. *Organometallics* **1987**, 6, 378. (c) Wettermark, U. G.; Wisian-Neilson, P.; Scheide, G. M.; Neilson, R. H. *Organometallics* **1987**, 6, 959.
36. (a) Peterson, D. K. *J. org. Chem.* **1968**, 33, 780. (b) Carey, F. A.; Court, A. S. *J. Org. Chem.* **1972**, 37, 939.
37. (a) Neilson, R. H.; Boyd, B. A.; Dubois, D. A.; Hani, R.; Scheide, G. M.; Shore, J. T.; Wettermark, U. G. *Phosphorous Sulfur* **1987**, 30, 463. (b) Scheide, G. M.; Neilson, R. H. *Organometallics* **1989**, 8, 1987.
38. Wolfsberger, W. Z. *Naturforsch., B: Anorg. Chem. Org. chem.* **1975**, 30B, 900.
39. Wettermark, U. G.; Neilson, R. H. *Inorg. Chem.* **1987**, 26, 929.
40. Wolfsberger, W. *J. Organomet. Chem.* **1975**, 86, C3.
41. Birkofer, L.; Kim, S. M. *Chem. Ber.* **1964**, 97, 2100.
42. Flindt, E. P. *Z. Anorg. Allg. Chem.* **1978**, 447, 97.
43. Stokes, H. N. *Am. Chem. J.* **1897**, 19, 782.

44. (a) Ritchie, R. J.; Harris, P. J.; Allcock, H. R. *Macromolecules* **1979**, *12*, 1014. (b) Allcock, H. R.; Ritchie, R. J.; Harris, P. J. *Macromolecules* **1980**, *13*, 1332.
45. Allcock, H. R.; Patterson, D. B. *Inorg. Chem.* **1977**, *16*, 197.
46. Flindt, E. P.; Rose, H. Z. *Anorg. Allg. Chem.* **1977**, *428*, 204.
47. (a) Neilson, R. H.; Hani, R.; Wisian-Neilson, P.; Meister, J. J.; Roy, A. K.; Hagnauer, G. L. *Macromolecules* **1987**, *20*, 910. (b) Neilson, R. H.; Hani, R.; Scheide, G. M.; Wettermark, U. G.; Wisian-Neilson, P.; Ford, R. R.; Roy, A. K. *ACS Symposium Series* **1988**, *360*, 283.
48. Ji, J. Ph.D. Dissertation, Texas Christian University, 1995.
49. (a) Montague, R. A.; Matyjaszewski, K. *J. Am. Chem. Soc.* **1990**, *112*, 6721. (b) Matyjaszewski, K.; Moore, M. K.; White, M. L. *Macromolecules* **1993**, *26*, 6741. (c) Matyjaszewski, K.; Franz, U.; Montague, R. A.; White, M. L. *Polymer* **1994**, *35*, 5005. (d) White, M. L.; Matyjaszewski, K. *J. Polymer Sci.: Part A: Polymer Chem.* **1996**, *34*, 277.
50. Gallazzi, M. C.; Freddi, G.; Sanvito, G.; Viscardi, G. *J. Inorg. Organomet. Polym.* **1996**, *6*, 277.
51. (a) Honeyman, C. H.; Manners, I.; Morrissey, C. T.; Allcock, H. R. *J. Am. Chem. Soc.* **1995**, *117*, 7035. (b) Allcock, H. R.; Crane, C. A.; Morrissey, C. T.; Nelson, J. M.; Reeves, S. D.; Honeyman, C. H.; Manners, I. *Macromolecules* **1996**, *29*, 7740.

52. (a) Allcock, H. R.; Nelson, J. M.; Reeves, S. D.; Honeyman, C. H.; Manners, I. *Macromolecules* **1997**, *30*, 50. (b) Allcock, H. R.; de Denus, C. R.; Prange, R.; Nelson, J. M. *Macromolecules* **1999**, *32*, 7999.
53. Allcock, H. R.; Reeves, S. D.; Nelson, J. M.; Manners, I. *Macromolecules* **2000**, *33*, 3999. (b) Nelson, J. M.; Allcock, H. R.; *Macromolecules* **1997**, *30*, 1854. (c) Allcock, H. R.; Nelson, J. M.; Prange, R.; Crane, C. A.; de Denus, C. R. *Macromolecules* **1999**, *32*, 5736. (d) Prange, R.; Allcock, H. R. *Macromolecules* **1999**, *32*, 6390.
54. (a) Karthikeyan, S.; Neilson, R. H. *Inorg. Chem.* **1999**, *38*, 2079. (b) Neilson, R. H.; Ji, J.; Narayan-Sarathy, S.; Smith, D. W.; Babb, D. A. *Phosphorous, Sulfur, and Silicon* **1999**, *144*, 221.
55. (a) Emsley, J.; Uday, P. B. *J. Chem. Soc. (A)* **1971**, 768. (b) Emsley, J.; Moore, J.; Udy, P. B. *J. Chem. Soc. (A)* **1971**, 2863. (c) Hneihen, A. S.; Allen, C. W. *Abstract of papers*, 216th ACS National Meeting **1998**, INORG 556.
56. (a) Abouchaccra, T.; Helioui, M.; Puskaric, E.; De Jaeger, R.; Heubel, J. *J. Chem. Research. Synop.* **1981**, 230. (b) Helioui, M.; De Jaeger, R.; Puskaric, E.; Heubel, J. *Makromol. Chem.* **1982**, *183*, 1137. (c) D'Halluin, G.; De Jaeger, R.; Chambrette, J. P.; Potin, Ph. *Macromolecules* **1992**, *25*, 1254.
57. (a) Herring, D. L. *Chem. Indus.* 1960, 717. (b) Paciorek, K. L.; Kratzer, R. *Inorg. Chem.* **1964**, *3*, 594.

58. (a) Matyjaszewski, K.; Montague, R.; Dauth, J.; Nuyken, O. *J. Polymer Sci.: Part A: Poly. Chem.* **1992**, *30*, 813. (b) Franz, U.; Nuyken, O.; Matyjaszewski, K. *Macromolecules* **1993**, *26*, 3723. (c) Franz, U.; Nuyken, O.; Matyjaszewski, K. *Macromol. Rapid Commun.* **1994**, *15*, 169. (d) Kojima, M.; Magill, J.H.; Cypryk, M.; White, M. L.; Franz, U.; Matyjaszewski, K. *Macromol. Chem. Phys.* **1994**, *195*, 1823.
59. (a) Wisian-Neilson, P.; Ford, R. R.; Neilson, R. H.; Roy, A. K. *Macromolecules* **1986**, *19*, 2089. (b) Wisian-Neilson, P.; Bailey, L.; Bahadur, M. *Macromolecules* **1994**, *27*, 7713.
60. (a) Wisian-Neilson, P.; Ford, R. R. *Organometallics* **1987**, *6*, 2258. (b) Wisian-Neilson, P.; Ford, R.R. *Macromolecules* **1989**, *22*, 72. (c) Wisian-Neilson, P.; Xu, G-F.; Wang, T. *Macromolecules* **1995**, *28*, 8657.
61. Wisian-Neilson, P.; Islam, M. S.; Ganapathiappan, S.; Scott, D. L.; Raghuveer, K. S.; Ford, R. R. *Macromolecules* **1989**, *22*, 4382.
62. Wisian-Neilson, P.; Zhang, C. *Macromolecules* **1998**, *31*, 9084.
63. Wisian-Neilson, P.; Huang, L.; Islam, M. Q.; Crane, R. A. *Polymer* **1994**, *35*, 4985.
64. Wisian-Neilson, P.; Schaefer, M. A. *Macromolecules* **1989**, *22*, 2003.
65. Wisian-Neilson, P.; Islam, M. S. *Macromolecules* **1989**, *22*, 2026.
66. Wisian-Neilson, P.; Zhang, C.; Koch, K. A. *Macromolecules* **1998**, *31*, 1808.

67. Wisian-Neilson, P.; Claypool, C. L.; Bahadur, M.; *Macromolecules* **1994**, *27*, 7494.
68. Wisian-Neilson, P.; Bahadur, M.; Iriarte, J. M.; Ford, R. R.; Wood, C. E. *Macromolecules* **1994**, *27*, 4471.
69. Allcock, H. R.; Fitzpatrick, R. J.; Salvati, L. *Chem. Mater.* **1991**, *3*, 1120.
70. Allcock, H. R.; Kwon, S. *Macromolecules* **1986**, *19*, 1502.
71. Allcock, H. R.; Lavin, K. D.; Tollefson, N. M.; Evans, T. L. *Organometallics* **1983**, *2*, 267.
72. (a) Allcock, H. R.; Fuller, T. J.; Evans, T. L. *Macromolecules* **1980**, *13*, 1325. (b) Allcock, H. R.; Lavin, K. D.; Tollefson, N. M.; Evans, T. L. *Organometallics* **1983**, *2*, 267. (c) Allcock, H. R.; Coggio, W. D.; Archibald, R. S.; Brennan, D. J. *Macromolecules* **1989**, *22*, 3571.
73. Wang, B. *Ph.D. Dissertation*, Texas Christian University, 2000.
74. Gleria, M.; Bolognesi, A.; Porzio, W.; Catellani, M.; Destri, S.; Audisio, G. *Macromolecules* **1987**, *20*, 469.
75. Roesky, H. W.; Lucke, M. *Angew. Chem. Int. ed. Engl.* **1989**, *28*, 493.
76. (a) Manners, I.; Allcock, H. R.; Renner, G.; Nuyken, O. *J. Am. Chem. Soc.* **1989**, *111*, 5478. (b) Allcock, H. R.; Coley, S. M.; Manners, I.; Nuyken, O.; Renner, G. *Macromolecules* **1991**, *24*, 2024. (c) Allcock, H. R.; Coley, S. M.; Morrisey, C. T. *Macromolecules* **1994**, *27*, 2904.

77. (a) Dodge, J. A.; Manners, I.; Allcock, H. R.; Renner, G.; Nuyken, O. *J. Am. Chem. Soc.* **1990**, *112*, 1268. (b) Allcock, H. R.; Dodge, J. A.; Manners, I. *Macromolecules* **1993**, *26*, 11.
78. (a) Liang, M.; Manners, I. *J. Am. Chem. Soc.* **1991**, *113*, 4044. (b) Ni, Y.; Stammer, A.; Liang, M.; Massey, J.; Vancso, G. J.; Manners, I. *Macromolecules* **1992**, *25*, 7119. (c) Ni, Y.; Park, P.; Liang, M.; Massey, J.; Waddling, C.; Manners, I. *Macromolecules* **1996**, *29*, 3401. (d) Gates, D. P.; McWilliams, A. R.; Manners, I. *Macromolecules* **1998**, *31*, 3494. (e) Gates, D. P.; Edwards, M.; Liable-Sands, L. M.; Rheingold, A. L.; Manners, I. *J. Am. Chem. Soc.* **1998**, *120*, 3249. (f) McWilliams, A. R.; Gates, D. P.; Edwards, M.; Liable-Sands, L. M.; Guzei, I.; Rheingold, A. L.; Manners, I. *J. Am. Chem. Soc.* **2000**, *122*, 8848.
79. (a) Pang, Z.; Gu, X.; Yekta, A.; Masoumi, Z.; Coll, J. B.; Winnik, M. A.; Manners, I. *Adv. Mater.* **1996**, *8*, 768. (b) Gates, D. P.; Manners, I. *J. Chem. Soc., Dalton, Trans.* **1997**, 2525. (c) Ruffolo, R.; Evans, C. E. B.; Liu, X.-H.; Ni, Y.; Pang, Z.; Park, P.; McWilliams, A. R.; Gu, X.; Lu, X.; Yekta, A.; Winnik, M. A.; Manners, I. *Anal. Chem.* **2000**, *72*, 1894.
80. (a) Roy, A. K. *J. Am. Chem. Soc.* **1992**, *114*, 1530. (b) Roy, A. K. *J. Am. Chem. Soc.* **1993**, *115*, 2598. (c) Roy, A. K.; Burns, G. T.; Lie, G. C.; Grigoras, S. *J. Am. Chem. Soc.* **1993**, *115*, 2604.
81. Chunechom, V.; Vidal, T. E.; Adams, H.; Turner, M. L. *Angew. Chem. Int. Ed.* **1998**, *37*, 1928.

82. (a) Manners, I. *Angew. Chem. Int. Ed. Engl.* **1996**, 35, 1602. (b) Chivers, T.; Doxsee, D. D.; Edwards, M.; Hilts, R. W. in *The Chemistry of Inorganic Ring Systems*, (Ed.: Steudel, R.) *Studies in Chemistry, Vol. 14*, Elsevier, 1992, p 291.
83. (a) Horn, H.-G.; Steger, W. *Makromol. Chem.* **1974**, 175, 1777. (b) Bilbo, J.; Sharts, C. M. *J. Polymer Sci., Part A-1* **1967**, 5, 2891. (c) Horn, H.-G. *Makromol. Chem.* **1970**, 138, 163. (d) Schroeder, H.; Reiner, J. R.; Knowles, T. A. *Inorg. Chem.* **1963**, 2, 393.
84. Broser, W.; Harrer, W. *Angew. Chem.* **1965**, 4, 1081.
85. (a) Conant, J. B.; Wallingford, V. H.; Gandheker, S. S. *J. Am. Chem. Soc.* **1923**, 45, 763. (b) Cook, H. G.; Ilett, J. D.; Saunders, B. C.; Stacey, G. J.; Watson, H. G.; Wilding, I. G. E.; Woodcock, S. J. *J. Chem. Soc.* **1949**, 2921.

VITA

Personal Background	Pradeep Kumar Devulapalli Hyderabad, India Son of Babu Rao and Krishnamma Married Madhavi Musnuru, August 18, 2004
Education	Bachelor of Science, Osmania University, Hyderabad, 1998 Master of Science, Organic Chemistry, Osmania University, Hyderabad, 2000 Doctor of Philosophy, Chemistry, Texas Christian University, Fort Worth, TX, 2007
Experience	Welch Research Assistantship, Texas Christian University, 2005-2007 Teaching Assistantship, Texas Christian University, 2002-2005 Junior Research Fellow, C.S.I.R., Osmania University, 2000-2002
Professional Memberships	American Chemical Society

Presentations and Publications

1. **Pradeep K. Devulapalli**, Amit K. Ghosh, Andrew R. Neilson, Bethany M. Neilson, Robert H. Neilson "Synthesis and Reactivity of (Silylanilino)phosphines", 231st ACS *National Meeting*, Atlanta, Georgia, **2006**.
2. **Pradeep K. Devulapalli**, Amit K. Ghosh, Andrew R. Neilson, Bethany M. Neilson, Robert H. Neilson "Synthesis and Reactivity of (Silylanilino)phosphines", *SRS*, Texas Christian University, Fort Worth, Texas, **2006**.
3. Robert H. Neilson, **Pradeep K. Devulapalli**, Amit K. Ghosh, Jian Cui "Silylanilino derivatives of Phosphorus and Boron", 11th *IRIS*, Oulu, Finland, **2006**.
4. Neilson, R. H.; **Devulapalli, P.**; Jackson, B. K.; A. R.; Parveen, S.; Wang, B. *ACS Symposium Series* **2006**, 917, 325-334.
5. Neilson, R. H.; **Devulapalli, P.**; Jackson, B. K.; Neilson, A. R.; Parveen, S.; Wang, B. "Synthesis and Reactivity of (Silylamino)- and (Silylanilino)phosphines" 227th ACS *National Meeting*, Anaheim, CA, **2004**.

ABSTRACT

SYNTHESIS AND REACTIVITY OF (SILYLANILINO)PHOSPHINES

by Pradeep Kumar Devulapalli, Ph.D., 2007
Department of Chemistry
Texas Christian University

Dissertation Advisor: Robert H. Neilson, Professor of Chemistry

The chemistry of polyphosphazenes and their derivatives has gained immense significance in the scientific community. Depending on the substituents, these materials exhibit a wide variety of chemical and physical properties and are potential candidates for many applications. These phosphazenes are often synthesized from organophosphorus compounds that contain silicon-nitrogen functional groups. The wide variety of reactions that can occur at the phosphorous and the facile cleavage of the Si-N bond makes them potential precursors to acyclic, cyclic, and polymeric P-N systems.

In this study, we report the synthesis, characterization, and reactivity of some representative examples of three new types of N-SiMe₃ functionalized phosphines.

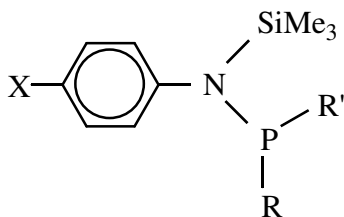

(Silylanilino)phosphines

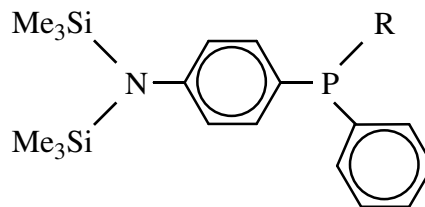

(Disilylanilino)phosphines

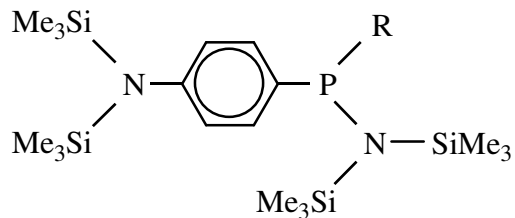

(Silylamino)(silylanilino)phosphines

The new phosphines were fully characterized by ^1H , ^{13}C , and ^{31}P NMR spectroscopy and by elemental analysis. Some oxidation reactions of these phosphines yielded new phosphoranimines which were also fully characterized. These anilinophosphines and their derivatives are being studied as precursors to traditional poly(phosphazenes) and novel poly(phenylenephosphazenes), i.e., new inorganic-organic hybrid polymers in which phosphazene ($-\text{R}_2\text{P}=\text{N}-$) and phenylene ($-\text{C}_6\text{H}_4-$) units alternate along the backbone. Oxidation reactions of some N-silylanilinophosphines and thermal condensation reactions of suitably substituted anilinophosphoranimines appear to form poly(phenylenephosphazenes) that are under further investigation in this laboratory.